

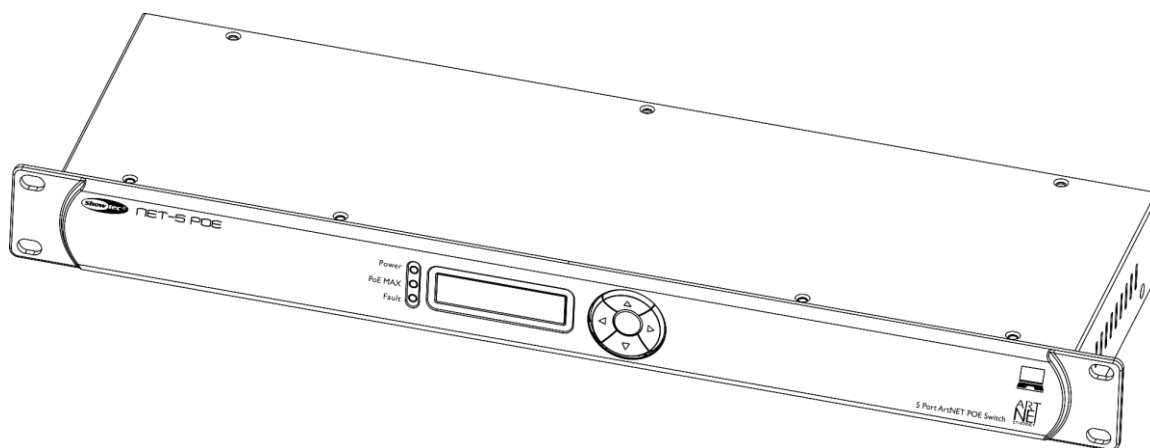

USER MANUAL



ENGLISH

Net-5 PoE

V1

Product code: 50811

Preface

Thank you for purchasing this Showtec product.

The purpose of this user manual is to provide instructions for the correct and safe use of this product.

Keep the user manual for future reference as it is an integral part of the product. The user manual shall be stored at an easily accessible location.

This user manual contains information concerning:

- Safety instructions
- Intended and non-intended use of the device
- Installation and operation of the device
- Maintenance procedures
- Troubleshooting
- Transport, storage and disposal of the device

Non-observance of the instructions in this user manual may result in serious injuries and damage of property.

©2020 Showtec. All rights reserved.

No part of this document may be copied, published or otherwise reproduced without the prior written consent of Highlite International.

Design and product specifications are subject to change without prior notice.

For the latest version of this document, please visit our website www.highlite.com or contact us at service@highlite.com.

Highlite International and its authorized service providers are not liable for any injury, damage, direct or indirect loss, consequential or economic loss or any other loss arising from the use of, or inability to use or reliance on the information contained in this document.

Table of contents

| | |
|---|-----------|
| 1. Introduction..... | 4 |
| 1.1. Before Using the Product | 4 |
| 1.2. Intended Use | 4 |
| 1.3. Text Conventions | 4 |
| 1.4. Acronyms and Abbreviations | 4 |
| 1.5. Symbols and Signal Words..... | 5 |
| 1.6. Symbols on the Information Label | 5 |
| 2. Safety | 5 |
| 2.1. Warnings and Safety Instructions | 6 |
| 2.2. Requirements for the User..... | 7 |
| 3. Description of the Device | 8 |
| 3.1. Front View | 8 |
| 3.2. Back View | 8 |
| 3.3. Product Specifications | 9 |
| 3.4. PoE Standards | 9 |
| 3.5. Dimensions..... | 10 |
| 4. Installation | 10 |
| 4.1. Safety Instructions for Installation | 10 |
| 4.2. Installation Site Requirements | 10 |
| 4.3. Rack Mounting | 11 |
| 4.4. Connecting to Power Supply | 11 |
| 4.5. Power Linking of Multiple Devices..... | 11 |
| 5. Setup | 12 |
| 5.1. Warnings and Precautions | 12 |
| 5.2. Ethernet Connection | 12 |
| 5.2.1. Network Cables | 12 |
| 5.2.2. Supported Pinout Modes | 13 |
| 5.3. Setup Example | 14 |
| 6. Operation | 15 |
| 6.1. Safety Instructions for Operation..... | 15 |
| 6.2. Control Panel | 15 |
| 6.3. LED Statuses..... | 16 |
| 6.4. Start-up..... | 17 |
| 6.5. Menu Overview | 18 |
| 6.6. Main Menu Options | 19 |
| 6.6.1. Rename | 19 |
| 6.6.2. Set DHCP | 19 |
| 6.6.3. Set IP Address | 20 |
| 6.6.4. Set Netmask..... | 20 |
| 6.6.5. Set LCD Backlight | 21 |
| 6.6.6. Set Display | 21 |
| 6.6.7. Set Default | 21 |
| 6.6.8. Version | 21 |
| 6.7. Configuration via Web Browser..... | 22 |
| 6.7.1. Changing the Password..... | 23 |
| 6.7.2. Updating the Firmware..... | 23 |
| 7. Troubleshooting | 24 |
| 8. Maintenance | 25 |
| 8.1. Safety Instructions for Maintenance..... | 25 |
| 8.2. Preventive Maintenance | 25 |
| 8.2.1. Basic Cleaning Instructions | 25 |
| 8.3. Corrective Maintenance..... | 25 |

8.3.1. Replacing the Fuse.....26

9. Deinstallation, Transportation and Storage26

10. Disposal26

11. Approval.....26

1. Introduction

1.1. Before Using the Product



Important
Read and follow the instructions in this user manual before installing, operating or servicing this product.

The manufacturer will not accept liability for any resulting damages caused by the non-observance of this manual.

After unpacking, check the contents of the box. If any parts are missing or damaged, contact your Highlite International dealer.

Your shipment includes:

- Showtec Net-5 PoE
- Schuko to pro-power cable (1,5 m)
- User manual

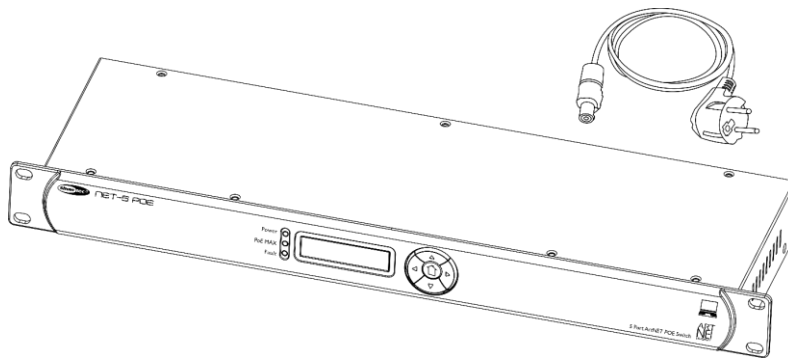

Fig. 01

1.2. Intended Use

This device is intended for use as an end-span switch. An end-span switch is a power sourcing equipment (PSE), which supplies DC power to the connected powered devices (PDs) through an Ethernet cable. It is suitable only for indoor installation.

Any other use, not mentioned under intended use, is regarded as non-intended and incorrect use.

1.3. Text Conventions

Throughout the user manual the following text conventions are used:

- Buttons: All buttons are in bold lettering, for example "Press the **UP/DOWN** buttons"
- References: References to chapters and parts of the device are in bold lettering, for example: "Refer to **2. Safety**", "press the **power switch (03)**"
- 0–255: Defines a range of values
- Notes: **Note:** (in bold lettering) is followed by useful information or tips

1.4. Acronyms and Abbreviations

| | | | |
|------|--|------|------------------------------|
| AC | Alternating Current | LED | Light-emitting Diode |
| CAT | Category | OLED | Organic Light-emitting Diode |
| DC | Direct Current | MPS | Maintain Power Signature |
| DHCP | Dynamic Host Configuration Protocol | PD | Powered Device |
| IEC | International Electrical Committee | PoE | Power over Ethernet |
| IP | (<i>technology</i>) Ingress Protection | PSE | Power Sourcing Device |
| IP | (<i>computing</i>) Internet Protocol | RU | Rack unit |
| LCD | Liquid Crystal Display | XLR | External Line Return |

1.5. Symbols and Signal Words

Safety notes and warnings are indicated throughout the user manual by safety signs.

Always follow the instructions provided in this user manual.



DANGER

Indicates an imminently hazardous situation which, if not avoided, will result in death or serious injury.



WARNING

Indicates an imminently hazardous situation which, if not avoided, could result in death or serious injury.



CAUTION

Indicates a potentially hazardous situation, which, if not avoided, may result in minor or moderate injury.



Attention

Indicates important information for the correct operation and use of the product.



Important

Read and observe the instructions in this document.



Electrical hazard



Provides important information about the disposal of this product.

1.6. Symbols on the Information Label

This product is provided with an information label. The information label is located on the base plate of the device.

The information label contains the following symbols:



This device is designed for indoor use.



This device shall not be treated as household waste.



This device falls under IEC protection class I.



Caution: Risk of electric shock. Disconnect input power before opening.

Warning: This appliance must be earthed.

2. Safety



Important

Read and follow the instructions in this user manual before installing, operating or servicing this product.

The manufacturer will not accept liability for any resulting damages caused by the non-observance of this manual.

2.1. Warnings and Safety Instructions



DANGER
Danger for children

For adult use only. The device must be installed beyond the reach of children.

- Do not leave various parts of the packaging (plastic bags, polystyrene foam, nails, etc.) within children's reach. Packaging material is a potential source of danger for children.



DANGER
Electric shock caused by short-circuit

This device falls under IEC protection class I.

- Do not insert objects, such as screwdrivers, wires, etc. into the connectors. Do not touch the connection terminals.
- Make sure that the device is electrically connected to ground (earth). Connect the device only to a socket-outlet with ground (earth) connection.
- Do not cover the ground (earth) connection.
- Do not bypass the thermostatic switch or fuses.
- For replacement use fuses of the same type and rating only.
- Do not let the power cable come into contact with other cables. Handle the power cable and all connections with the mains with caution.
- Do not modify, bend, mechanically strain, put pressure on, pull or heat up the power cable.
- Make sure that the power cable is not crimped or damaged. Examine the power cable periodically for any defects.
- Do not immerse the device in water or other liquids. Do not install the device in a location where flooding may occur.
- Do not use the device during thunderstorms. Disconnect the device from the electrical power supply immediately.



WARNING
Electric shock caused by dangerous voltage inside

There are areas within the device where dangerous touch voltage may be present.

- Do not open the device or remove any covers.
- Do not operate the device if the covers are open.
- Disconnect the device from electrical power supply before service and maintenance, and when the device is not in use.



Attention
Power supply

- Before connecting the device to the power supply, make sure that the current, voltage and frequency match the input voltage, current and frequency specified on the information label on the device.
- Make sure that the cross-sectional area of the extension cords and power cables is sufficient for the required power consumption of the device.

**Attention
General safety**

- Do not block the ventilation openings. Without proper heat dissipation and air circulation, the internal components may overheat. This can result in product damage.
- Do not shake the device. Avoid brute force when installing or operating the device.
- If the device is dropped or struck, disconnect the device from the electrical power supply immediately.
- If the device is exposed to extreme temperature variations (e.g. after transportation), do not switch it on immediately. Let the device reach room temperature before switching it on, otherwise it may be damaged by the formed condensation.
- If the device fails to work properly, discontinue the use immediately.

**Attention
This device shall be used only for the purposes it is designed for.**

This device is designed to be used as an end-span switch. Any incorrect use may lead to hazardous situations and result in injuries and material damage.

This device does not contain user-serviceable parts. Unauthorized modifications to the device will render the warranty void. Such modifications may result in injuries and material damage.

**Attention
Do not expose the device to conditions that exceed the rated IP class conditions.**

This device is IP20 rated. IP (Ingress Protection) 20 class provides protection against solid objects greater than 12 mm, such as fingers, and no protection against harmful ingress of water.

2.2. Requirements for the User

This product may be used by ordinary persons. Maintenance and installation may be carried by ordinary persons. Service shall be carried out only by instructed or skilled persons. Contact your Highlite International dealer for more information.

Instructed persons have been instructed and trained by a skilled person, or are supervised by a skilled person, for specific tasks and work activities associated with the service of this product, so that they can identify risks and take precautions to avoid them.

Skilled persons have training or experience, which enables them to recognize risks and to avoid hazards associated with the service of this product.

Ordinary persons are all persons other than instructed persons and skilled persons. Ordinary persons include not only users of the product but also any other persons that may have access to the device or who may be in the vicinity of the device.

3. Description of the Device

The Showtec Net-5 PoE is a plug-and-play, unmanaged Ethernet switch, which can supply power over Ethernet (PoE) to a maximum of 4 connected devices. The 4 PoE ports can supply up to 30 W per port.

3.1. Front View

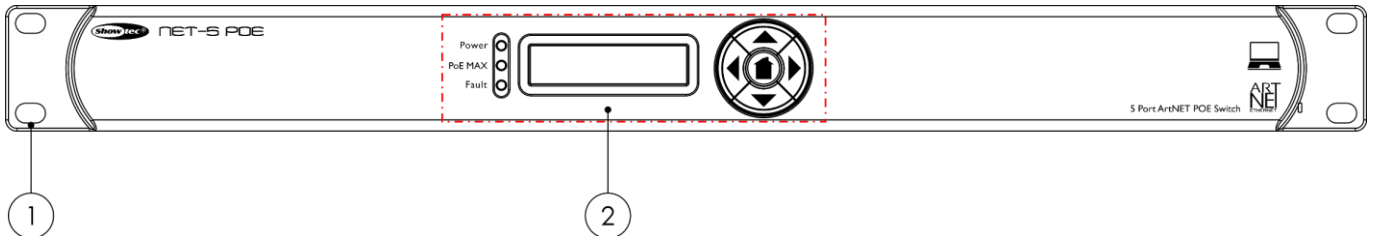

Fig. 02

- 01) 4 x mounting openings (for installation in a 19-inch rack)
- 02) Control panel: OLED display, control buttons and LED indicators

3.2. Back View

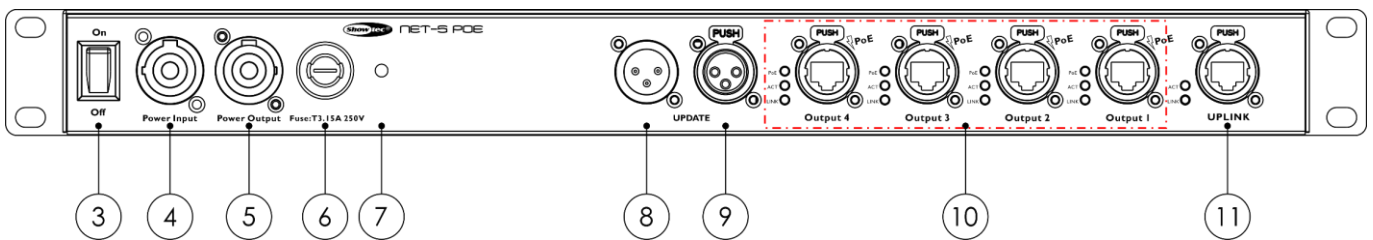

Fig. 03

- 03) Power switch
- 04) Pro-power connector IN (Blue)
- 05) Pro-power connector OUT (Gray)
- 06) Fuse T3, 1.5 A, 250 V
- 07) Ground (earth) connection
- 08) 3-pin XLR signal connector IN for updating purposes
- 09) 3-pin XLR signal connector OUT for updating purposes
- 10) 4 output PoE ports with RJ45 connectors and LED indicators
- 11) Uplink port with RJ45 connector and LED indicators

3.3. Product Specifications

| | |
|--------|-----------|
| Model: | Net-5 PoE |
|--------|-----------|

| | |
|--------------------|------------------------|
| Electrical: | |
| Input voltage: | 100–240 V AC, 50/60 Hz |
| Power consumption: | 150 W |
| Fuse: | T3,15 A, 250 V |

| | |
|------------------|-------------------------------|
| Physical: | |
| Dimensions: | 482 x 137 x 44 mm (L x W x H) |
| Weight: | 2,3 kg |

| | |
|-----------------------------|----------------------------|
| PoE support: | |
| PoE standards: | IEEE 802.3af, IEEE 802.3at |
| Maximum PoE budget: | 120 W |
| PoE maximum power per port: | 30 W |
| Maximum power for PD: | 25,5 W |
| Voltage at PSE: | 50–57 V DC, 600 mA |
| Voltage at PD: | 42,5–57 V DC |

| | |
|-------------------------------|--------------------------|
| Operation and control: | |
| Ethernet speed: | 10/100/1000Base-T |
| Switch capacity: | 10 Gbps |
| Transmission rate: | 1,488 Mpps per port |
| Internet protocol: | TCP/IPv4 |
| Control panel: | OLED display and buttons |

| | |
|---------------------|--|
| Connections: | |
| Power connections: | Pro-power connectors IN/OUT |
| Data connections: | 4 x output PoE RJ45 connectors |
| | 1 uplink RJ45 connector |
| | 3-pin XLR connectors IN/OUT for updating purposes only |

| | |
|----------------------|--------------------------|
| Construction: | |
| Housing: | Metal |
| Color: | Black |
| IP rating: | IP20 |
| Cooling: | Natural heat dissipation |

| | |
|--|-------|
| Thermal: | |
| Maximum ambient temperature t_{α} : | 40 °C |

3.4. PoE Standards

| Standard | Type | Voltage at PD | Voltage at PSE | Power at PD | Maximum power at PSE | Maximum current |
|----------|--------|---------------|----------------|-------------|----------------------|-----------------|
| 802.3af | Type 1 | 37–57 V DC | 44–57 V DC | 12,95 W | 15,4 W | 350 mA |
| 802.3at | Type 2 | 42,5–57 V DC | 50–57 V DC | 25,5 W | 30 W | 600 mA |
| 802.3bt | Type 3 | 42,5–57 V DC | 50–57 V DC | 51 W | 60 W | 600 mA per pair |
| | Type 4 | 41,1–57 V DC | 52–57 V DC | 71 W | 100 W | 960 mA per pair |

3.5. Dimensions

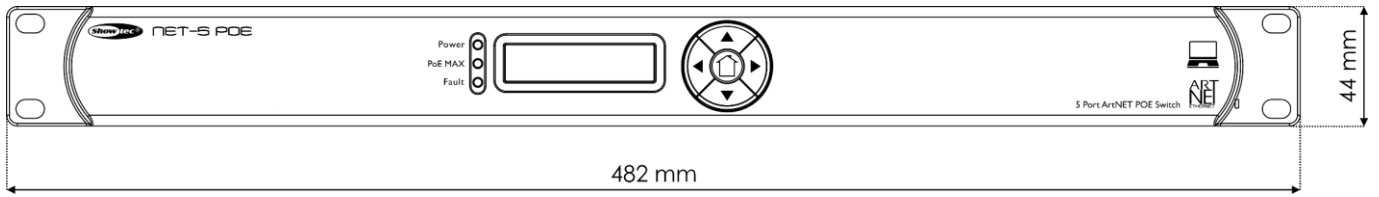

Fig. 04

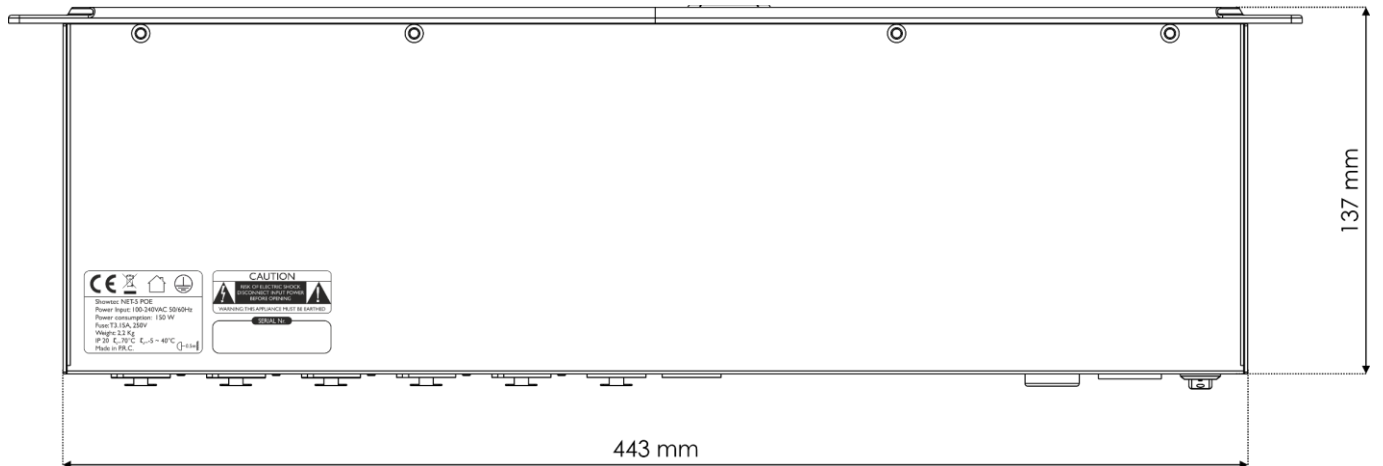

Fig. 05

4. Installation

4.1. Safety Instructions for Installation



Attention

Make sure there is enough space for ventilation around the device.

- Do not block the ventilation openings. Without proper heat dissipation and air circulation, the internal components may overheat. This can result in product damage.
- Do not install near equipment that produces heat, for example amplifiers.

4.2. Installation Site Requirements

- The device must be installed only indoors.
- The device can be placed on a flat surface or mounted in a standard 19-inch rack.
- The maximum ambient temperature $t_a = 40\text{ °C}$ must never be exceeded.
- The relative humidity must not exceed 50 % with an ambient temperature of 40 °C.

4.3. Rack Mounting

The device can be mounted in a standard 19-inch rack. The device requires 1 rack unit (RU) of space, which is 44,45 mm high.

Make sure that the rack is sufficiently secured to prevent it from becoming unstable or falling over.

To mount the device in a two-post rack, follow the steps below:

- 01) Insert 4 cage nuts in the openings on the rack posts where you want to mount the device.
- 02) Position the device in front of the rack posts so that the 4 **mounting openings (01)** on the flanges face the openings on the rack posts with cage nuts.
- 03) Using a screwdriver, mount the device to the rack posts with 4 screws.

4.4. Connecting to Power Supply



DANGER
Electric shock caused by short-circuit

The device accepts AC mains power at 100–240 V and 50/60 Hz. Do not supply power at any other voltage or frequency to the device.

This device falls under IEC protection class I. Make sure that the device is always electrically connected to the ground (earth).

Before connecting the device to the socket-outlet:

- Make sure that the power supply matches the input voltage specified on the information label on the device.
- Make sure that the socket-outlet has ground (earth) connection.

Connect the device to the socket-outlet with the power plug.

4.5. Power Linking of Multiple Devices

This device supports power linking. Power can be relayed to another device via the power OUT connector. Note that the input and the output connectors have different designs: one type cannot be connected to the other.

Power linking of multiple devices must be carried out only by instructed or skilled persons.



WARNING
Incorrect power linking may lead to overload of the electrical circuit and result in serious injuries and damage of property.

To prevent overload of the electrical circuit, when power linking multiple devices:

- Use cables with sufficient current-carrying capacity. The power cable supplied with the device is not suitable for power linking of multiple devices.
- Make sure that the total current draw of the device and all connected devices does not exceed the rated capacity of the power cables and the circuit breaker.
- Do not link more devices on one power link than the maximum recommended number.

Maximum recommended number of devices:

- at 100–120 V: 5 devices Net-5 PoE
- at 200–240 V: 15 devices Net-5 PoE

5. Setup

5.1. Warnings and Precautions



Attention
 Connect all data cables before supplying power.
 Disconnect power supply before connecting or disconnecting data cables.

5.2. Ethernet Connection

The Net-5 PoE is an Ethernet switch, which can deliver data and supply power over a standard Ethernet cable to a maximum of 4 connected powered devices (PDs). The connected powered devices must support PoE (Power over Ethernet).

5.2.1. Network Cables

Standard twisted-pair Ethernet cables (CAT-5/CAT-5E/CAT-6) can be used to connect the device to the lighting controller/computer and to the powered devices.

If you make your own network cables, make sure that you connect the pins and wires correctly as shown in Fig. 06. Use RJ45 (8P8C) connectors and patch the cables according to the T568B color standard.

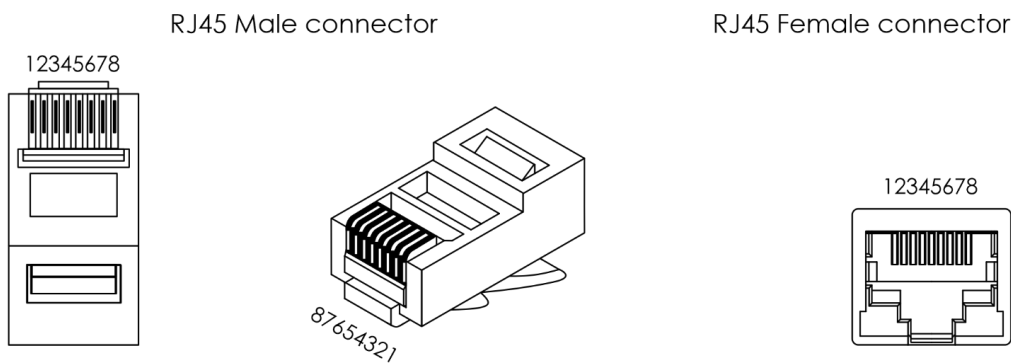

Color Standard EIA/TIA T568B

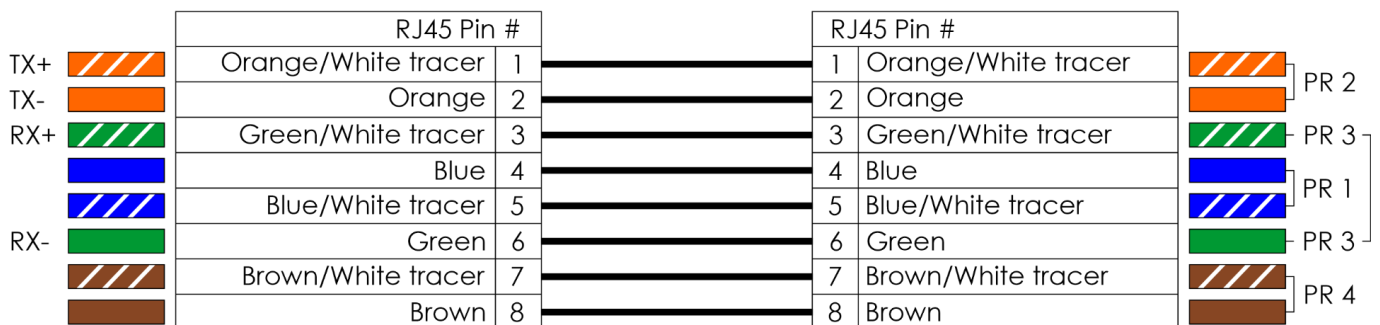
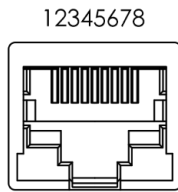









Fig. 06

5.2.2. Supported Pinout Modes

The Net-5 PoE supports the following 2 pinout modes: 1000 mode A and 1000 mode B.

RJ45 Female connector



| RJ45 Pin # | | 1000 mode A | | 1000 mode B | |
|------------|---------------------|---|--------------|-------------|-----|
| 1 | Orange/White tracer |  | TXRX A + DC+ | TXRX A + | |
| 2 | Orange |  | TXRX A - DC+ | TXRX A - | |
| 3 | Green/White tracer |  | TXRX B + DC- | TXRX B + | |
| 4 | Blue |  | TXRX C + | TXRX C + | DC+ |
| 5 | Blue/White tracer |  | TXRX C - | TXRX C - | DC+ |
| 6 | Green |  | TXRX B - DC- | TXRX B - | DC- |
| 7 | Brown/White tracer |  | TXRX D + | TXRX D + | DC- |
| 8 | Brown |  | TXRX D - | TXRX D - | DC- |

Color Standard EIA/TIA T568B

Fig. 07

5.3. Setup Example

The Net-5 PoE has 1 uplink RJ45 connector and 4 output PoE RJ45 connectors.

- 01) Use a CAT-5/CAT-5E/CAT-6 cable to connect the RJ45 connector of the lighting controller/computer to the uplink RJ45 connector of the device.
- 02) Connect up to 4 PDs to the output PoE RJ45 connectors of the device with a CAT-5/CAT-5E/CAT-6 cable, as shown in Fig. 08. Start with Output 1 and continue with Output 2, etc.
- 03) Connect the light effects or similar equipment to the PDs in the desired setup. Follow the connection instructions in the user manual of the respective PDs.

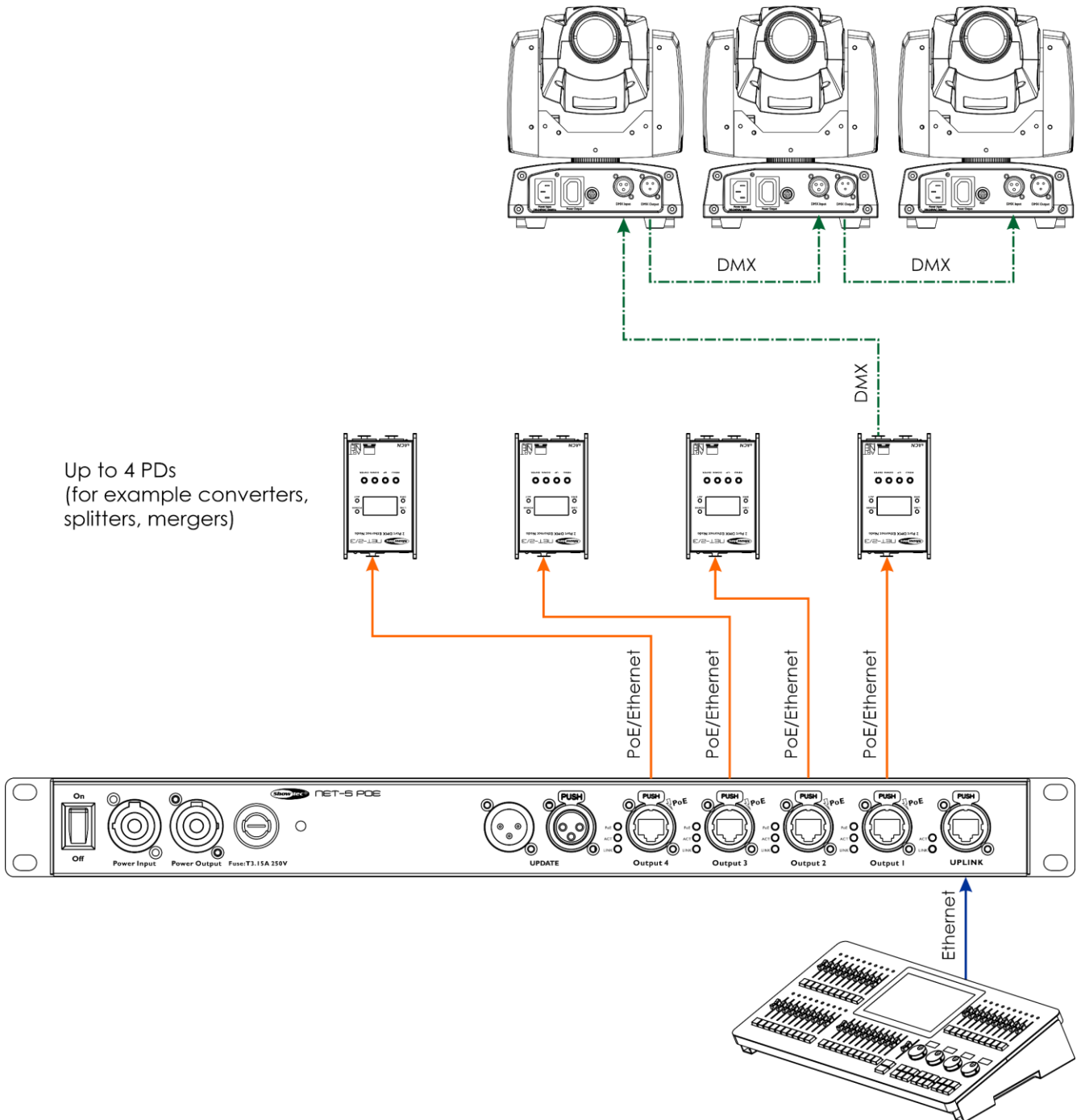

Fig. 08

Note:

The total Ethernet cable length must not exceed 100 m.

6. Operation

6.1. Safety Instructions for Operation



Attention

This device must be used only for the purposes it is designed for.

This device is intended for use as an end-span switch. An end-span switch is a power sourcing equipment (PSE), which supplies DC power to the connected powered devices (PDs) through an Ethernet cable.

Any other use, not mentioned under intended use, is regarded as non-intended and incorrect use.



Attention

Power supply

Before connecting the device to the power supply, make sure that the current, voltage and frequency match the input voltage, current and frequency specified on the information label on the device.

6.2. Control Panel

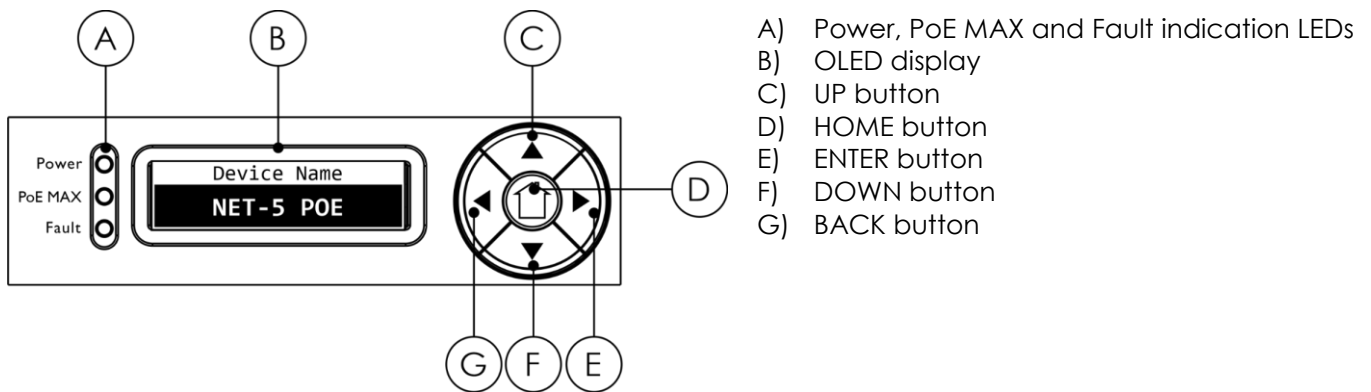

Fig. 09

- Use the **HOME** button to access the main menu from the start screen.
- Use the **BACK** button to exit the current submenu and to return to the main menu.
- Use the **UP/DOWN** buttons to navigate through the menus and to scroll through the available characters/numbers.
- Use the **ENTER** button to open the desired menu, to confirm your choice or to set the currently selected character/number.

Note:

If the display is rotated at 180°, the function of the buttons on the control panel will be reversed as well.

- The **BACK** button will function as **ENTER** button and vice versa.
- The **UP** button will function as **DOWN** button and vice versa.

6.3. LED Statuses

There are 3 LED indicators on the **control panel (02)** of the device, 3 LED indicators at each **output PoE port (10)**, and 2 LED indicators at the **uplink port (11)**.

The 3 LED indicators on the **control panel (02)** have following functions:

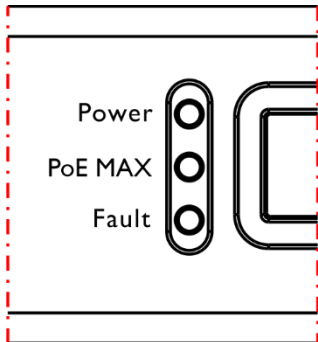

Fig. 10

- **Power:** If the light is on, the device is powered.
- **PoE MAX:** If the light is on, the PoE maximum power of 30 W at one of the ports is exceeded.
Note: If the PoE maximum power is exceeded at one of the ports, the last connected PD will be automatically disconnected from the port.
- **Fault:** If the light is on, one or more errors have occurred. Refer to **7. Troubleshooting** on page 24 for more information.

The 3 LED indicators at each **output PoE port (10)** have the following functions:

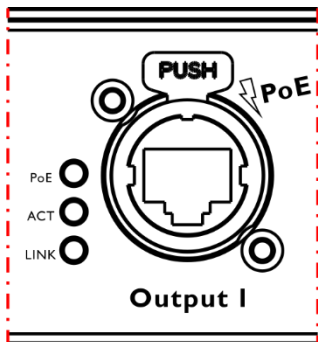

Fig. 11

- **PoE:** If the light is on, the port is supplying PoE to the connected PD.
- **ACT:** If the light is on, there is network activity at the port.
- **LINK:** If the light is on, a network signal is received at the port at 1000 Mbps. If the light is off, the speed is 100 Mbps or 10 Mbps.

The 2 LED indicators at the **uplink port (11)** have the following functions:

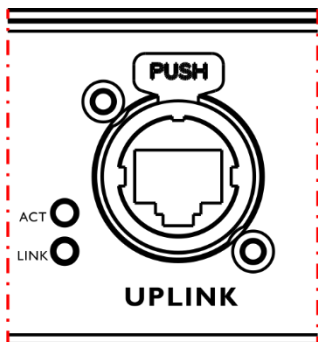

Fig. 12

- **ACT:** If the light is on, there is network activity at the port.
- **LINK:** If the light is on, a network signal is received at the port at 1000 Mbps. If the light is off, the speed is 100 Mbps or 10 Mbps.

6.4. Start-up

The device has a power switch.

- Press the **power switch (03)** in ON position to turn the device on.
- Press the **power switch (03)** in OFF position to turn the device off.

At start-up the OLED display shows the status menu. The status menu provides information about the device and the status of the ports.

01) Press the **UP/DOWN** buttons to navigate through the 4 start screens of the status menu:

| Device Name | |
|-------------|--|
| NET-5 POE | |

Device Name

- The name of the device. To change the name, see **6.6.1. Rename** on page 19

| IP Address | |
|---------------|--|
| 2.116.179.202 | |

IP Address

- The IP address of the device. To set the IP address, see **6.6.2. Set DHCP** on page 19 and **6.6.3. Set IP address** on page 20

| Network Status | | | | | |
|----------------|----|---|---|---|---|
| Port | UP | 1 | 2 | 3 | 4 |
| Stat | ✓ | ✓ | x | x | x |

Network Status

- Port: UP (uplink), 1, 2, 3, 4
- Stat (status): (✓) the port is connected; (x) the port is not connected

| PSE Status | | | | |
|------------|---|---|---|---|
| Port | 1 | 2 | 3 | 4 |
| Power | ✓ | x | x | x |

PSE Status

- Port: 1, 2, 3, 4
- Power: (✓) the port is connected to a powered device (PD); (x) the port is not connected

02) Press the **HOME** button to enter the main menu.

Note:

If no button is pressed, after 30 seconds of inactivity the display will return to the last viewed screen from the status menu.

6.5. Menu Overview

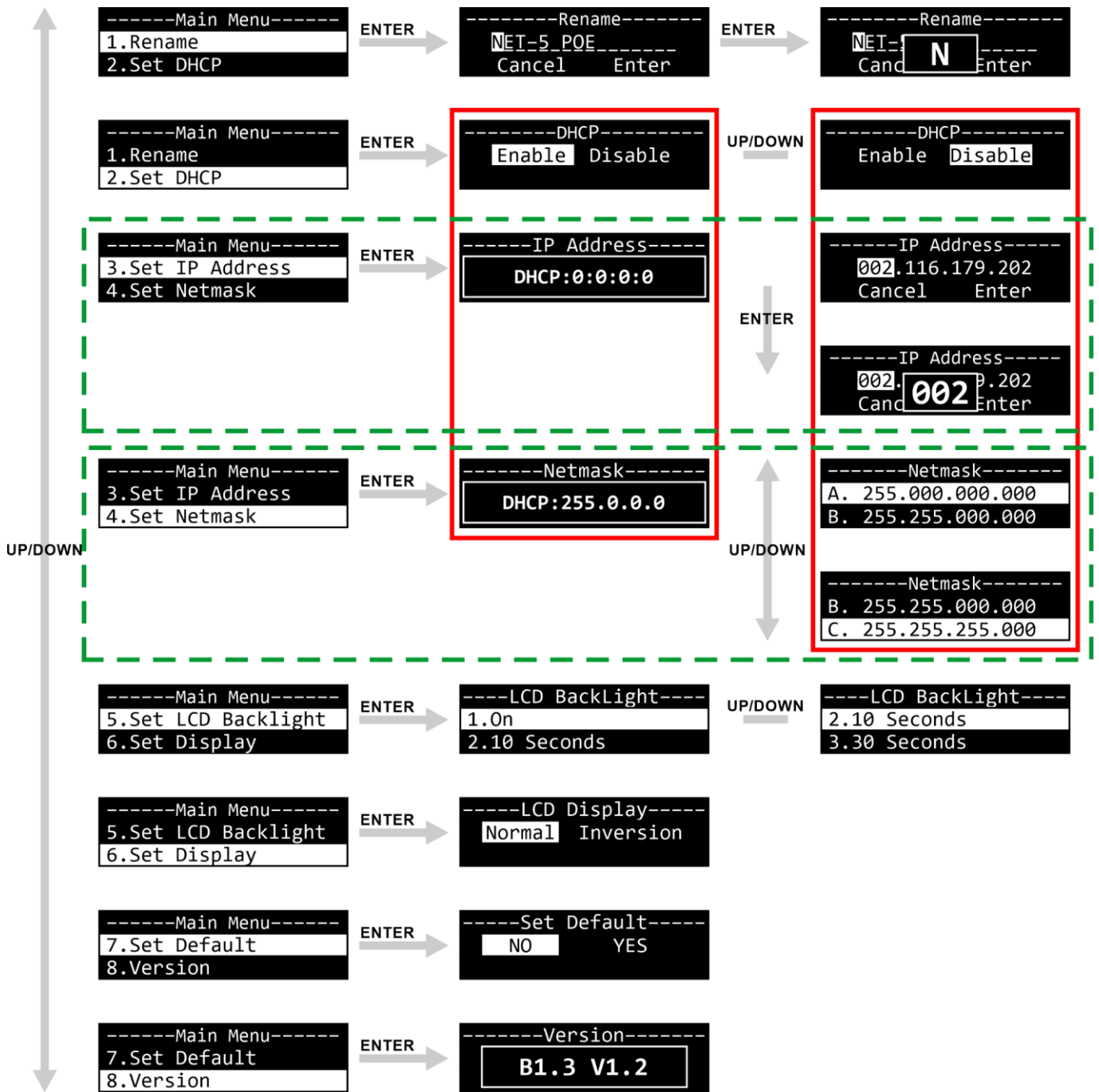

6.6. Main Menu Options

The main menu has the following options:

```

-----Main Menu-----
1.Rename
2.Set DHCP
3.Set IP Address
4.Set Netmask
5.Set LCD Backlight
6.Set Display
7.Set Default
8.Version
    
```

- 01) Press the **UP/DOWN** buttons to navigate through the main menu.
- 02) Press the **ENTER** button to open the submenus.

6.6.1. Rename

In this menu you can change the name of the device.

- 01) Press the **UP/DOWN** buttons to move the cursor respectively to the left or to the right on the display. When the cursor reaches the last available position on the line, it will move to the second line.
- 02) Press the **ENTER** button to confirm the selection. The selected character will be highlighted.

```

-----Rename-----
NET: N
Cancel Enter
    
```

- 03) Press the **UP/DOWN** buttons to change the character. The available characters are lowercase and uppercase letters, digits, punctuation marks, and some symbols.
- 04) Press the **ENTER** button to confirm or the **BACK** button if you want to cancel and return to step 1.
- 05) Repeat steps 1–4 for each character of the name. The maximum length of the name is 16 characters.
- 06) Press the **UP/DOWN** buttons to select Cancel to discard the changes or Enter to confirm the new name.
- 07) Press the **ENTER** button to confirm the selection.

6.6.2. Set DHCP

In this menu you can enable the DHCP configuration of the IP address.

- 01) Press the **UP/DOWN** buttons to toggle between Enable and Disable:

```

-----DHCP-----
Enable Disable
    
```

- Enable: The IP address of the device will be generated automatically by the network server
 - Disable: You can configure the IP address of the device manually. For more information refer to **6.6.3. Set IP Address** on page 20
- 02) Press the **ENTER** button to confirm the selection.

6.6.3. Set IP Address

If you have enabled the DHCP configuration in **6.6.2. Set DHCP**, when you select Set IP Address in the menu, the display will show the following:

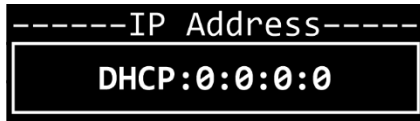

The IP address of the device is generated automatically by the network server.

If you have disabled the DHCP configuration, you can configure the IP address of the device manually.

- 01) Press the **UP/DOWN** buttons to move the cursor respectively to the left or to the right on the display. When the cursor reaches the last available position on the line, it will move to the second line.
- 02) Press the **ENTER** button to confirm the selection. The selected number will be highlighted.



- 03) Press the **UP/DOWN** buttons to change the number. The selection range is between 0 and 255.
- 04) Press the **ENTER** button to confirm or the **BACK** button if you want to cancel and return to step 1.
- 05) Repeat steps 1–4 for each of the remaining 3 sections.
- 06) Press the **UP/DOWN** buttons to toggle between Cancel to discard the changes and Enter to confirm the IP address.
- 07) Press the **ENTER** button to confirm the selection.

6.6.4. Set Netmask

If you have enabled the DHCP configuration in **6.6.2. Set DHCP**, when you select Set Netmask in the menu, the display will show the following:



The Netmask of the IP address of the device is generated automatically by the network server.

If you have disabled the DHCP configuration, you can set the Netmask of the IP address of the device.

- 01) Press the **UP/DOWN** buttons to scroll through the following 3 options:



- 02) Press the **ENTER** button to confirm the selection.

6.6.5. Set LCD Backlight

In this menu you can select whether the backlight of the display will remain on or will turn off after the selected amount of time.

01) Press the **UP/DOWN** buttons to select one of the following 3 options:



- On: The backlight of the OLED display does not turn off
- 10 seconds: The backlight turns off automatically after 10 seconds of inactivity
- 30 seconds: The backlight turns off automatically after 30 seconds of inactivity

02) Press the **ENTER** button to confirm the selection.

6.6.6. Set Display

In this menu you can select the orientation of the display.

01) Press the **UP/DOWN** buttons to toggle between Normal and Inversion:

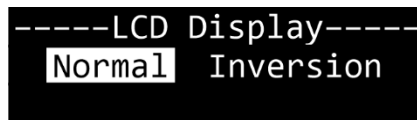

- Normal: Normal orientation of the display
- Inversion: The display will be rotated at 180°

02) Press the **ENTER** button to confirm your choice.

Note:

If the display is rotated at 180°, the function of the buttons on the control panel will be reversed as well.

- The **BACK** button will function as **ENTER** button and vice versa.
- The **UP** button will function as **DOWN** button and vice versa.

6.6.7. Set Default

In this menu you can reset the device's settings to the default factory settings.

01) Press the **UP/DOWN** buttons to choose between NO and YES. If you choose YES, the device's settings will be reset to the default factory settings.

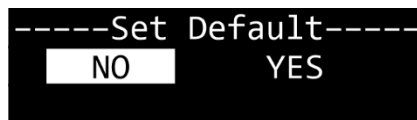

02) Press the **ENTER** button to confirm your choice.

6.6.8. Version

In this menu you can view the firmware version of the device.



6.7. Configuration via Web Browser

The Net-5 PoE can be configured remotely via a web interface. To connect the device to a web browser follow the steps below:

- 01) Connect the Net-5 PoE to a laptop/computer.
- 02) Configure the network address of the laptop/computer in the correct range (IP 2.x.x.x or 10.x.x.x and Netmask 255.0.0.0).
- 03) Open a web browser and enter the IP address of the Net-5 PoE in the address bar. The IP address of the device is available on the status menu. See **6.4. Start-up** on page 17 for more information.
- 04) Press the **Enter** key on the laptop/computer keyboard.
- 05) Enter the log-in details when prompted:
 - Log-in account: Admin
 - Password: Admin (You can change the password after you log in)

Note:

If you change a setting via the control panel, you need to refresh the web browser to see the new setting in the browser window.

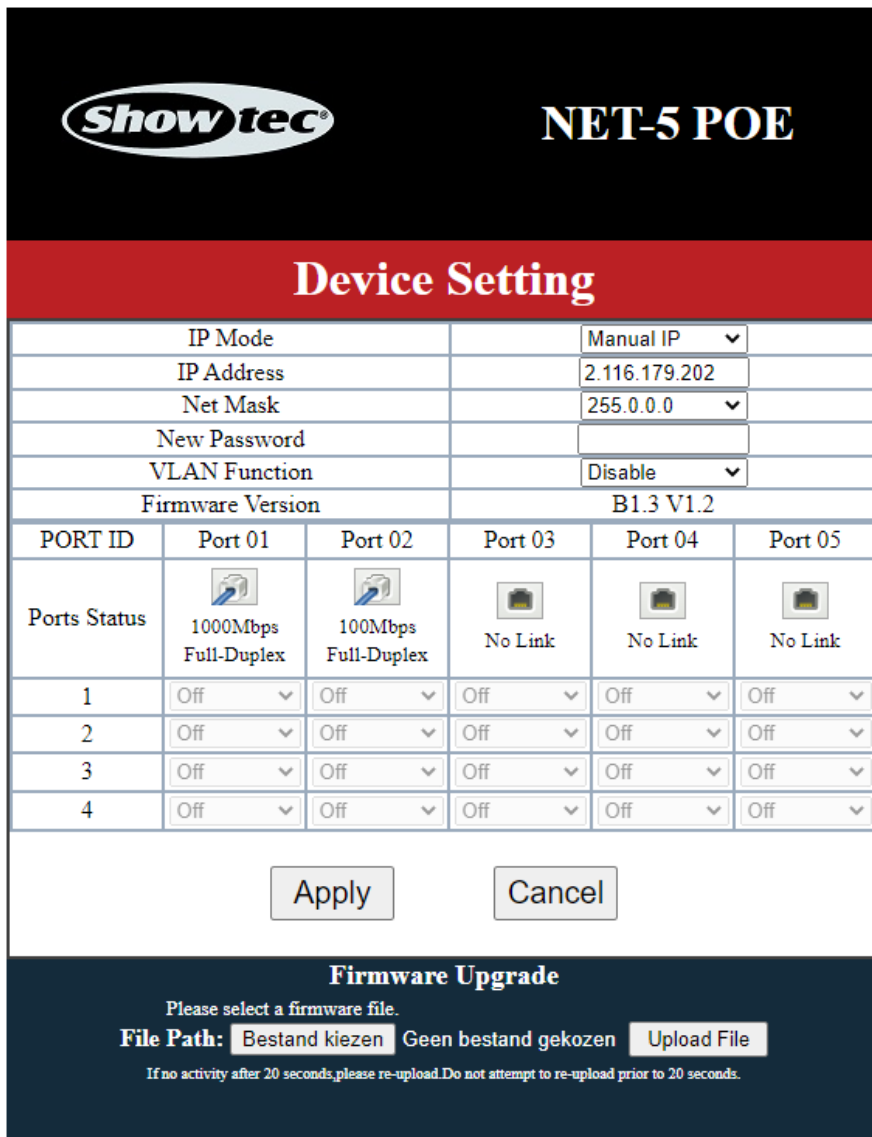

From the web browser you can configure the IP mode, the IP address, and the Netmask of the device, and set a new password for the web interface. For the available configuration options, refer to the respective sections in **6.6. Main Menu Options** on pages 19–21.

- Use the drop-down menus or enter the respective values to configure the settings of the device.
- Click **Apply** to save the changes.
- Click **Cancel** to discard the changes.

The web browser provides also information about which ports are connected.

The numbering of the ports is as follows:

Uplink port = Port 01

Output 1 = Port 02

Output 2 = Port 03

Output 3 = Port 04

Output 4 = Port 05

6.7.1. Changing the Password

To change the password, proceed as follows:

- 01) Log in with your current password.
- 02) Enter the new password in the New Password field.
- 03) Click **Apply** to save the changes.

6.7.2. Updating the Firmware

The firmware of the Net-5 PoE can be updated via the web interface. If an update is available for this device, you can download it from the product's page on www.highlite.com.

- 01) Click **Choose File** and browse to the location where the firmware update file is saved.
- 02) Select the file.
- 03) Click **Open** on the dialog box to confirm the selection.
- 04) Click **Upload File** to start the firmware update process.
- 05) Follow the instructions on the browser to complete the update.

Note:

It can take up to 20 seconds to update the firmware. Do not click any buttons before the update is complete.

After completion of the firmware update, reset the Net-5 PoE to factory defaults. See **6.6.7. Set Default** on page 21 for more information. When you update the firmware, all previously configured settings will be lost.

7. Troubleshooting

This troubleshooting guide contains solutions to problems which can be carried out by an ordinary person. The device does not contain user-serviceable parts.

Unauthorized modifications to the device will render the warranty void. Such modifications may result in injuries and material damage.

Refer servicing to instructed or skilled persons. Contact your Highlite International dealer in case the solutions, described in the following 2 tables, do not work.

If the device does not function according to the specifications, proceed as follows:

- 01) Check the LED indicator statuses.
- 02) If one or more LED indicators have statuses as described in the table below, use the table to find the probable cause and carry out the respective solutions.

| LED status | Probable cause | Possible solution |
|-------------------------|--|--|
| Power indicator is off | No power to the device | <ul style="list-style-type: none"> • Check if power is switched on and the power cable is plugged in |
| | Main fuse is blown | <ul style="list-style-type: none"> • Replace the fuse. See 8.3.1. Replacing the Fuse on page 26 |
| PoE Max indicator is on | The PoE maximum budget is exceeded | <ul style="list-style-type: none"> • Check the compatibility of the connected PDs. Restart the PDs by disconnecting and reconnecting them |
| Fault indicator is on | One of the following faults has occurred: Port Overload, Port Short Circuit Limit, Port MPS error, Port Severe Short Circuit, Port Thermal Shutdown, Temperature Limit | <ul style="list-style-type: none"> • Switch off the PSE and disconnect the power supply. Disconnect all cables. Wait for 10–15 minutes. Reconnect all cables, connect the PSE to the power supply and switch it on. If the fault indicator is still on or if it lights up after a while, contact your Highlite International dealer |

- 03) If the PoE max LED indicator and/or the Fault indicator is off, use the table below to find the probable cause and carry out the respective solutions.

| Problem | Probable cause | Possible solution |
|-------------------------|---|--|
| No PoE on only one port | The connected PD is not compatible or is defective | <ul style="list-style-type: none"> • Check the compatibility of the PD. Try connecting another PD on the same port |
| | The Ethernet cable connecting the PD does not comply with the PoE standards | <ul style="list-style-type: none"> • Replace the Ethernet cable |
| | The total Ethernet cable length exceeds 100 m | <ul style="list-style-type: none"> • Make changes to the setup and reduce the total Ethernet cable length |
| No PoE on all ports | The total Ethernet cable length exceeds 100 m | <ul style="list-style-type: none"> • Disconnect all PDs and connect only one PD. If the PD receives PoE, make changes to the setup and reduce the total Ethernet cable length |
| | The PSE or the PoE section may be defective | <ul style="list-style-type: none"> • Switch off the PSE and contact your Highlite International dealer |
| No data transfer | The factory settings of the device are changed | <ul style="list-style-type: none"> • Reset the device's parameters to the default factory settings. See 6.6.7. Set Default on page 21 |
| | The Ethernet cables are not correctly connected | <ul style="list-style-type: none"> • Disconnect all Ethernet cables and reconnect them |
| | The device is not correctly connected to the network | <ul style="list-style-type: none"> • Check the connection and the settings and correct, if necessary |

- 04) If you cannot find the problem or the solutions do not work, contact your Highlite International dealer.

8. Maintenance

8.1. Safety Instructions for Maintenance



DANGER
Electric shock caused by dangerous voltage inside

Disconnect power supply before servicing or cleaning.

8.2. Preventive Maintenance



Attention
Before use, examine the device visually for any defects.

Make sure that:

- All screws used for installing the device or parts of the device are tightly fastened and are not corroded.
- There are no deformations on housings, fixations and installation points.
- The power cables are not damaged and do not show any material fatigue.

8.2.1. Basic Cleaning Instructions

To clean the device, follow the steps below:

- 01) Disconnect the device from the electrical power supply.
- 02) Allow the device to cool down for 5 minutes.
- 03) Clean the device with a soft, lint-free cloth.



Attention

- Do not immerse the device in liquid.
- Do not use alcohol or solvents.

8.3. Corrective Maintenance

The device does not contain user-serviceable parts. Do not open the device and do not modify the device.

Refer repairs and servicing to instructed or skilled persons. Contact your Highlite International dealer for more information.

8.3.1. Replacing the Fuse



DANGER
Electric shock caused by short-circuit

- Do not bypass the thermostatic switch or fuses.
- For replacement use fuses of the same type and rating only.

Power surges, short-circuit or incorrect electrical power supply may cause a fuse to burn out. If the fuse burns out, the device will not function anymore. If this happens, follow the steps below:

- 01) Disconnect the device from the electrical power supply.
- 02) Allow the device to cool down for 5 minutes.
- 03) Loosen the fuse cover with a screwdriver and remove the fuse holder.
- 04) If the fuse is brown or unclear, it is burned out. Remove the old fuse.
- 05) Insert a new fuse in the fuse holder. Make sure that the type and the rating of the replacement fuse are the same as the ones specified on the information label of the product.
- 06) Replace the fuse holder in the opening and tighten the fuse cover.

9. Deinstallation, Transportation and Storage

- Disconnect power supply before deinstallation.
- Use the original packaging to transport the device, if possible.
- Clean the device before storing. Follow the cleaning instructions in chapter **8.2.1. Basic Cleaning Instructions** on page 25.
- Store the device in the original packaging, if possible.

10. Disposal

Correct disposal of this product

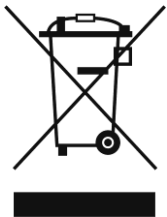

Waste Electrical and Electronic Equipment

This symbol on the product, its packaging or documents indicates that the product shall not be treated as household waste. Dispose of this product by handing it to the respective collection point for recycling of electrical and electronic equipment. This is to avoid environmental damage or personal injury due to uncontrolled waste disposal. For more detailed information about recycling of this product contact the local authorities or the authorized dealer.

11. Approval



Check the respective product page on the website of Highlite International (www.highlite.com) for an available declaration of conformity.



©2020 Showtec