

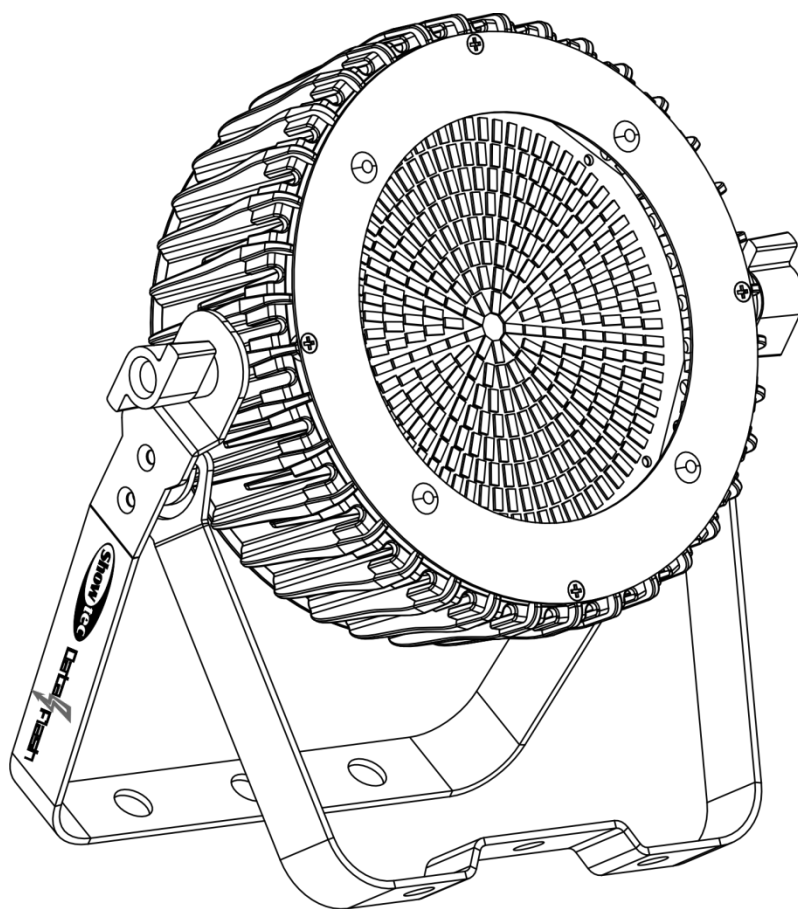

MANUAL



ENGLISH

Data Flash Strobe

V3

Ordercode: 40296

Table of contents

Warning	2
Safety Instructions	2
Operating Determinations	4
Rigging	4
Connection with the mains	5
Return Procedure	6
Claims	6
Description of the device	7
Frontside	7
Backside	8
Installation	8
Set Up and Operation	8
Control Modes	9
One Data Flash Strobe (Auto Run Mode and Built-in programs)	9
One Data Flash Strobe (Sound-controlled)	9
Multiple Data Flash Strobes (Master/Slave control)	9
Multiple Data Flash Strobes (DMX Control)	10
Fixture Linking	11
Data Cabling	11
Control Panel	12
Control Mode	12
DMX Addressing	12
Menu Overview	13
Main Menu Options	14
1. Auto Run Mode	14
2. Built-in Programs	14
3. Slave Mode	14
4. DMX Addressing	15
5. Sound control Mode	15
6. Dimmer	15
7. Settings	16
8. Info	18
DMX Channels	18
2 channels	18
3 channels	18
12 channels	19
Maintenance	20
Troubleshooting	20
No Light	20
No Response to DMX	20
Product Specifications	22
Dimensions	23
Notes	24

Warning



**For your own safety, please read this user manual carefully
before your initial start-up!**



Unpacking Instructions

Immediately upon receiving this product, carefully unpack the carton and check the contents to ensure that all parts are present, and have been received in good condition. Notify the dealer immediately and retain packing material for inspection if any parts appear damaged from shipping or the carton itself shows signs of mishandling. Save the carton and all packing materials. In the event that a fixture must be returned to the factory, it is important that the fixture be returned in the original factory box and packing.

Your shipment includes:

- Showtec Data Flash Strobe
- Pro power cable (1,5 m)
- User manual

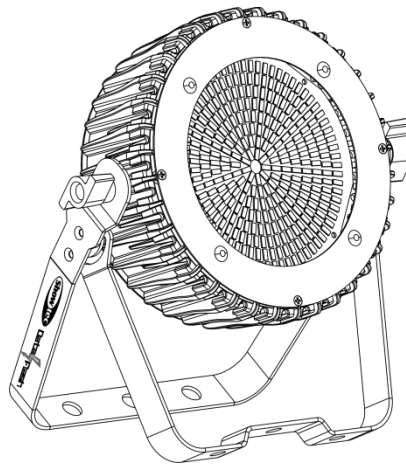

LED Expected Lifespan

LEDs gradually decline in brightness over time. HEAT is the dominant factor that leads to the acceleration of this decline. Packaged in clusters, LEDs exhibit higher operating temperatures than in ideal or singular optimum conditions. For this reason, when all color LEDs are used at their fullest intensity, life of the LEDs is significantly reduced. If improving the lifespan is of higher priority, place care in providing for lower operational temperatures. This may include climatic-environmental and the reduction of overall projection intensity.



CAUTION!

**Keep this device away from rain and moisture!
Unplug mains lead before opening the housing!**



Safety Instructions

Every person involved with the installation, operation and maintenance of this device has to:

- be qualified
- follow the instructions of this manual



**CAUTION! Be careful with your operations.
With a dangerous voltage you can suffer
a dangerous electric shock when touching the wires!**



Before the initial start-up, please make sure that there is no damage caused by transportation. Should there be any, consult your dealer and do not use the device.

To maintain perfect condition and to ensure a safe operation, it is absolutely necessary for the user to follow the safety instructions and warning notes contained in this manual.

Please consider that damages caused by manual modifications to the device are not subject to warranty.

This device contains no user-serviceable parts. Refer servicing to qualified technicians only.

IMPORTANT:

The manufacturer will not accept liability for any resulting damages caused by the non-observance of this manual or any unauthorized modification to the device.

- Never let the power cord come into contact with other cables! Handle the power cord and all connections with the mains with particular caution!
- Never remove warning or informative labels from the unit.
- Never use anything to cover the ground contact.
- Never lift the fixture holding it by the projector-head, as the mechanics may be damaged. Always hold the fixture by the transport handles.
- Never place any material over the lens.
- Never look directly into the light source.
- Never leave any cables lying around.
- Do not connect this device to a dimmerpack.
- Do not switch the device on and off in short intervals, as this will reduce the device's life.
- Do not touch the device's housing bare-handed during its operation (housing becomes very hot). Allow the fixture to cool for at least 5 minutes before handling.
- Do not shake the device. Avoid brute force when installing or operating the device.
- Only use the device indoors, avoid contact with water or other liquids.
- Only operate the fixture after having checked if the housing is firmly closed and all screws are tightly fastened.
- Only operate the device after having familiarized with its functions.
- Avoid flames and do not put close to flammable liquids or gases.
- Always keep the case closed while operating.
- Always allow a free air space of at least 50 cm around the unit for ventilation.
- Always disconnect power from the mains, when device is not used or before cleaning! Only handle the power cord holding it by the plug. Never pull out the plug by tugging the power cord.
- Make sure that the device is not exposed to extreme heat, moisture or dust.
- Make sure that the available voltage is not higher than stated on the rear panel.
- Make sure that the power cord is never crimped or damaged. Check the device and the power cord from time to time.
- If the lens is obviously damaged, it has to be replaced.
- If device was dropped or struck, disconnect mains power supply immediately. Have a qualified engineer inspect for safety before operating.
- If the device has been exposed to drastic temperature fluctuation (e.g. after transportation), do not switch it on immediately. The arising condensation water might damage your device. Leave the device switched off until it has reached room temperature.
- If your Showtec device fails to work properly, discontinue the use immediately. Pack the unit securely (preferably in the original packing material), and return it to your Showtec dealer for service.
- For adult use only. The fixture must be installed beyond the reach of children. Never leave the unit running unattended.
- Never attempt to bypass the thermostatic switch or fuses.
- For replacement use fuses of same type and rating only.
- The user is responsible for correct positioning and operating of the Data Flash Strobe. The manufacturer will not accept liability for damages caused by the misuse or incorrect installation of this device.
- This device falls under protection class I. Therefore it is essential to connect the yellow/green conductor to earth.

- Repairs, servicing and electric connection must be carried out by a qualified technician.
- WARRANTY: Till one year after date of purchase.

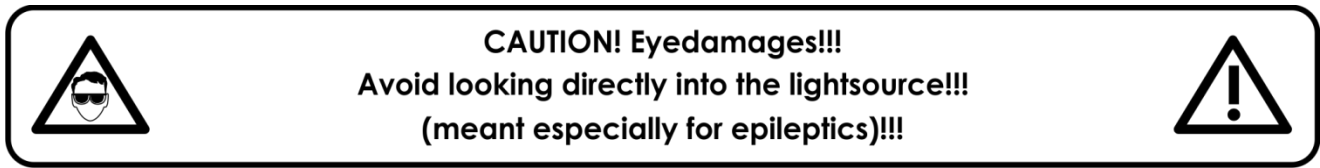

Operating Determinations

- This device is not designed for permanent operation. Consistent operation breaks will ensure that the device will serve you for a long time without defects.
- The minimum distance between light output and the illuminated surface must be bigger than 1 meter.
- The maximum ambient temperature $t_a = 40^\circ\text{C}$ must never be exceeded.
- The relative humidity must not exceed 50 % with an ambient temperature of 40°C .
- If this device is operated in any other way than the one described in this manual, the product may suffer damages and the warranty becomes void.
- Any other operation may lead to dangers like short-circuit, burns, electric shock, crash, etc.

You endanger your own safety and the safety of others!

Rigging

Please follow the European and national guidelines concerning rigging, trussing and all other safety issues.

Do not attempt the installation yourself !

Always let the installation be carried out by an authorized dealer !

Procedure:

- If the Data Flash Strobe is lowered from the ceiling or high joists, professional trussing systems have to be used.
- Use a clamp to mount the Data Flash Strobe, with the mounting bracket, to the trussing system.
- The Data Flash Strobe must never be fixed swinging freely in the room.
- The installation must always be secured with a safety attachment, e.g. an appropriate safety net or safety cable.
- When rigging, derigging or servicing the Data Flash Strobe, always make sure, that the area below the installation site is secured and that there are not any unauthorized people around.

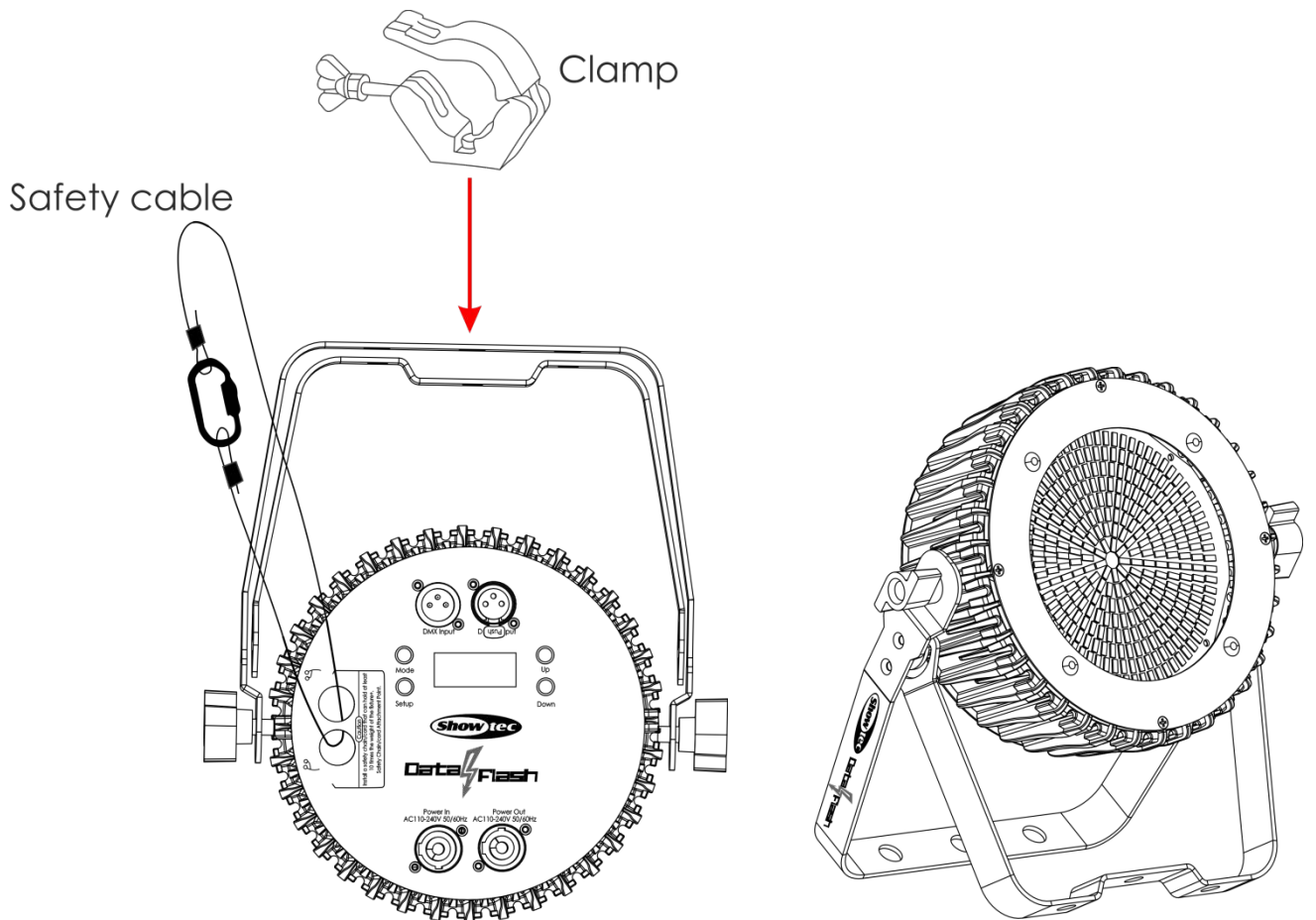

The Data Flash Strobe can be placed on a flat stage floor or mounted to any kind of truss with a clamp.

Improper installation can cause serious injuries and/or damage of property!

Connection with the mains

Connect the device to the mains with the power-plug.
Always check if the right color cable is connected to the right place.

International	EU Cable	UK Cable	US Cable	Pin
L	BROWN	RED	YELLOW/COPPER	PHASE
N	BLUE	BLACK	SILVER	NEUTRAL
⊕	YELLOW/GREEN	GREEN	GREEN	PROTECTIVE GROUND

Make sure that the device is always properly connected to the earth!

Improper installation can cause serious injuries and/or damage of property!



Return Procedure

Returned merchandise must be sent prepaid and in the original packing, call tags will not be issued. Package must be clearly labeled with a Return Authorization Number (RMA number). Products returned without an RMA number will be refused. Highlite will not accept the returned goods or any responsibility. Call Highlite 0031-455667723 or mail aftersales@highlite.nl and request an RMA prior to shipping the fixture. Be prepared to provide the model number, serial number and a brief description of the cause for the return. Be sure to properly pack fixture, any shipping damage resulting from inadequate packaging is the customer's responsibility. Highlite reserves the right to use its own discretion to repair or replace product(s). As a suggestion, proper UPS packing or double-boxing is always a safe method to use.

Note: If you are given an RMA number, please include the following information on a piece of paper inside the box:

- 01) Your name
- 02) Your address
- 03) Your phone number
- 04) A brief description of the symptoms

Claims

The client has the obligation to check the delivered goods immediately upon delivery for any shortcomings and/or visible defects, or perform this check after our announcement that the goods are at their disposal. Damage incurred in shipping is the responsibility of the shipper; therefore the damage must be reported to the carrier upon receipt of merchandise.

It is the customer's responsibility to report and submit claims with the shipper in the event that a fixture is damaged due to shipping. Transportation damage has to be reported to us within one day after receipt of the delivery.

Any return shipment has to be made post-paid at all times. Return shipments must be accompanied with a letter defining the reason for return shipment. Non-prepaid return shipments will be refused, unless agreed otherwise in writing.

Complaints against us must be prepared in writing or sent by fax within 10 working days after receipt of the invoice. After this period complaints will not be handled anymore.

Complaints will only then be considered if the client has so far complied with all parts of the agreement, regardless of the agreement from which the obligation is resulting.

Description of the device

Features

The Data Flash Strobe is a compact LED strobe with an intense strobe effect. It has 8 sections which can be used for creating dynamic strobe effects.

- 8 controllable sections
- Double mounting bracket
- Pro power connections
- Input voltage: 110-240V AC, 50/60Hz
- Power consumption: 120W
- DMX channels: 2, 3, 12 channels
- LCD display for easy setup
- Light source: SMD LEDs
- Control modes: Auto, Built-in Programs, Sound-controlled, Master/Slave, DMX
- Control protocol: DMX-512
- Dimmer: 0-100%
- Strobe: 0-20Hz
- Protection rate: IP-20
- Housing: Aluminum
- Cooling: Convection
- Connections: Pro power connector IN/OUT (Blue/Gray) & 3-pin XLR IN & OUT
- Dimensions: 263 x 83 x 293 mm (LxWxH)
- Weight: 2,6 kg

Frontside

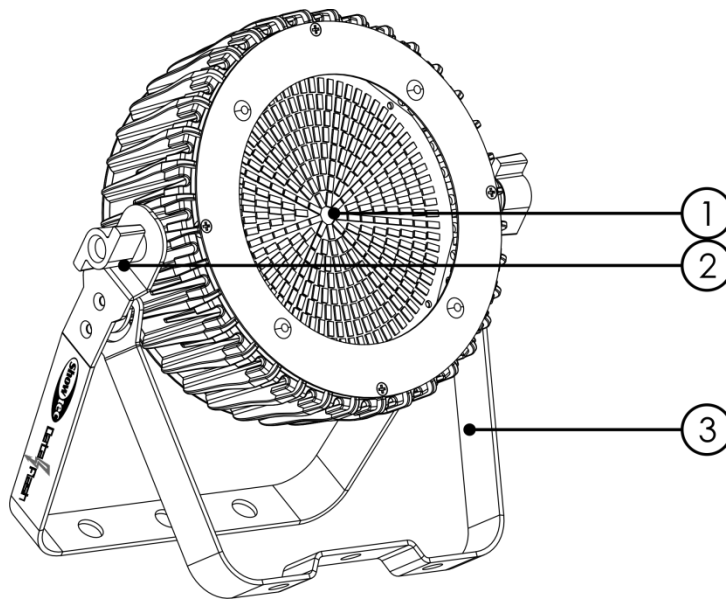

Fig. 01

- 01) 8 sections SMD LEDs
- 02) Adjustment screw
- 03) Mounting bracket with inclination screw

Backside

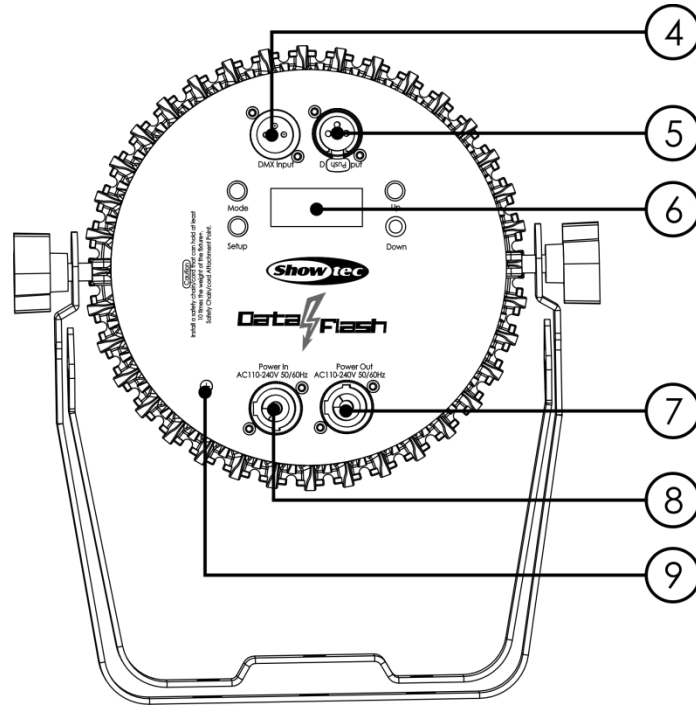

Fig. 02

- 04) 3-pin DMX signal connector IN
- 05) 3-pin DMX signal connector OUT
- 06) LCD display + menu buttons
- 07) 110-240V AC Pro power connector OUT (Gray)
- 08) 110-240V AC Pro power connector IN (Blue)
- 09) Ground/earth connection

Installation

Remove all packing materials from the Data Flash Strobe. Check if all foam and plastic padding is removed. Connect all cables.

Do not supply power before the whole system is set up and connected properly.

Always disconnect from electric mains power supply before cleaning or servicing.

Damages caused by non-observance are not subject to warranty.

Set Up and Operation

Follow the directions below, as they pertain to your preferred operation mode.

Before plugging the unit in, always make sure that the power supply matches the product specification voltage. Do not attempt to operate a 120V specification product on 230V power, or vice versa.

Connect the device to the main power supply.

Control Modes

There are 5 modes:

- Auto run
- Built-in programs
- Sound-controlled
- Master/slave
- DMX-512 (2CH, 3CH, 12 CH)

One Data Flash Strobe (Auto Run Mode and Built-in programs)

- 01) Fasten the effect light to a firm trussing. Leave at least 0,5 meter on all sides for air circulation.
- 02) Plug the end of the electric mains power cord into a proper electric power supply socket.
- 03) When the Data Flash Strobe is not connected with a DMX cable, it functions as a stand-alone device. Please see page 14 for more information about Auto Run Mode and the Built-in programs.

One Data Flash Strobe (Sound-controlled)

- 01) Fasten the effect light to a firm trussing. Leave at least 0,5 meter on all sides for air circulation.
- 02) Plug the end of the electric mains power cord into a proper electric power supply socket.
- 03) Turn on the music. If the device is set to sound-control, then the Data Flash Strobe will react to the beat of the music. Please see page 15 for more information about the sound-control options.

Multiple Data Flash Strobes (Master/Slave control)

- 01) Fasten the effect light onto firm trussing. Leave at least 0,5 meter on all sides for air circulation.
- 02) Always use a safety cable (ordercode 70140 / 70141).
- 03) Use a 3-pin XLR cable to connect the Data Flash Strobe and other devices.

The pins:



1. Earth
2. Signal (-)
3. Signal (+)

- 04) Link the units as shown in fig. 03, connect a DMX signal cable from the first unit's DMX "out" socket to the second unit's "in" socket. Repeat this process to link the second, third, and fourth units. You can use the same functions on the master device as described on page 14 (Built-in Programs). This means you can set your desired operation mode on the master device and all slave devices will react the same as the master device.

Multiple Data Flash Strobes (Master/Slave control)

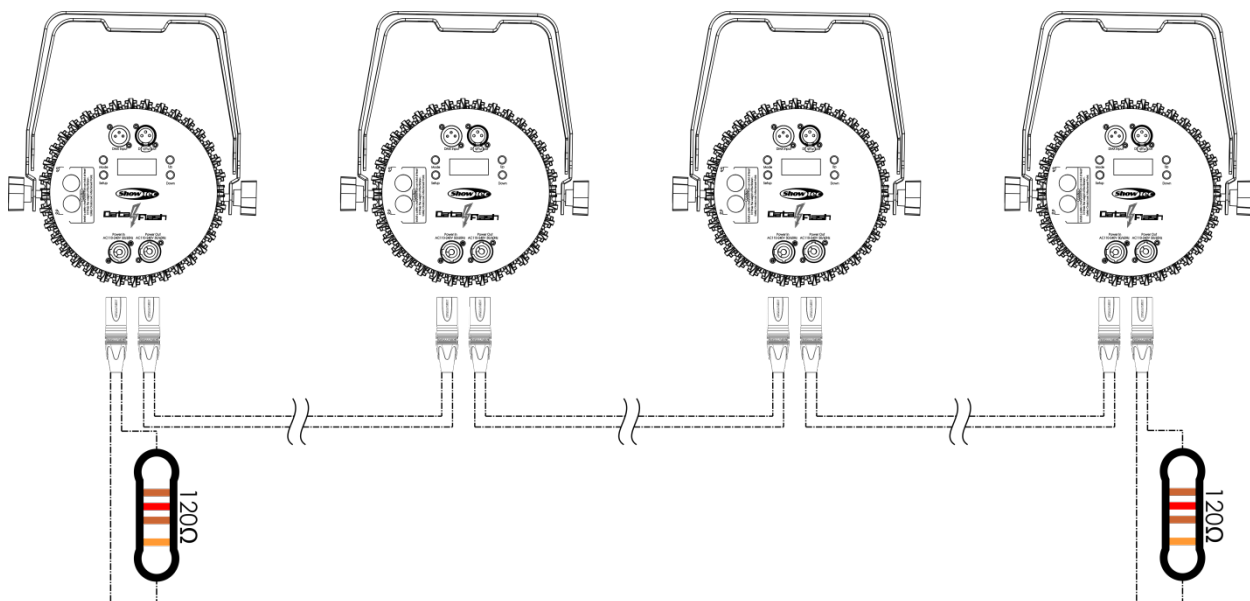
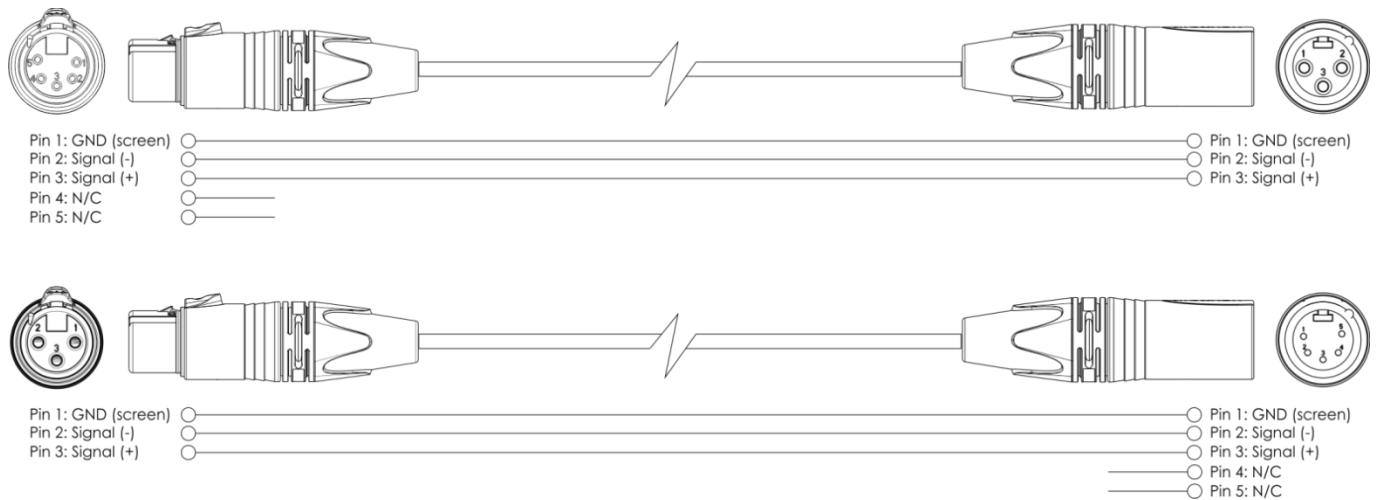

Fig. 03

Multiple Data Flash Strobes (DMX Control)

- 01) Fasten the effect light to a firm trussing. Leave at least 0,5 meter on all sides for air circulation.
- 02) Always use a safety cable (ordercode 70140 / 70141).
- 03) Use a 3-pin XLR cable to connect the Data Flash Strobes and other devices.



- 04) Link the units as shown in fig. 04. Connect the first unit's DMX "out" socket with the second unit's "in" socket, using a DMX-signal cable. Repeat this process to link the second, third, and fourth units.
- 05) Supply electric power: Plug electric mains power cords into each unit's Pro power socket, then plug the other end of the mains power cord into proper electric power supply sockets, starting with the first unit. Do not supply power before the whole system is set up and connected properly.

Multiple Data Flash Strobes Set Up

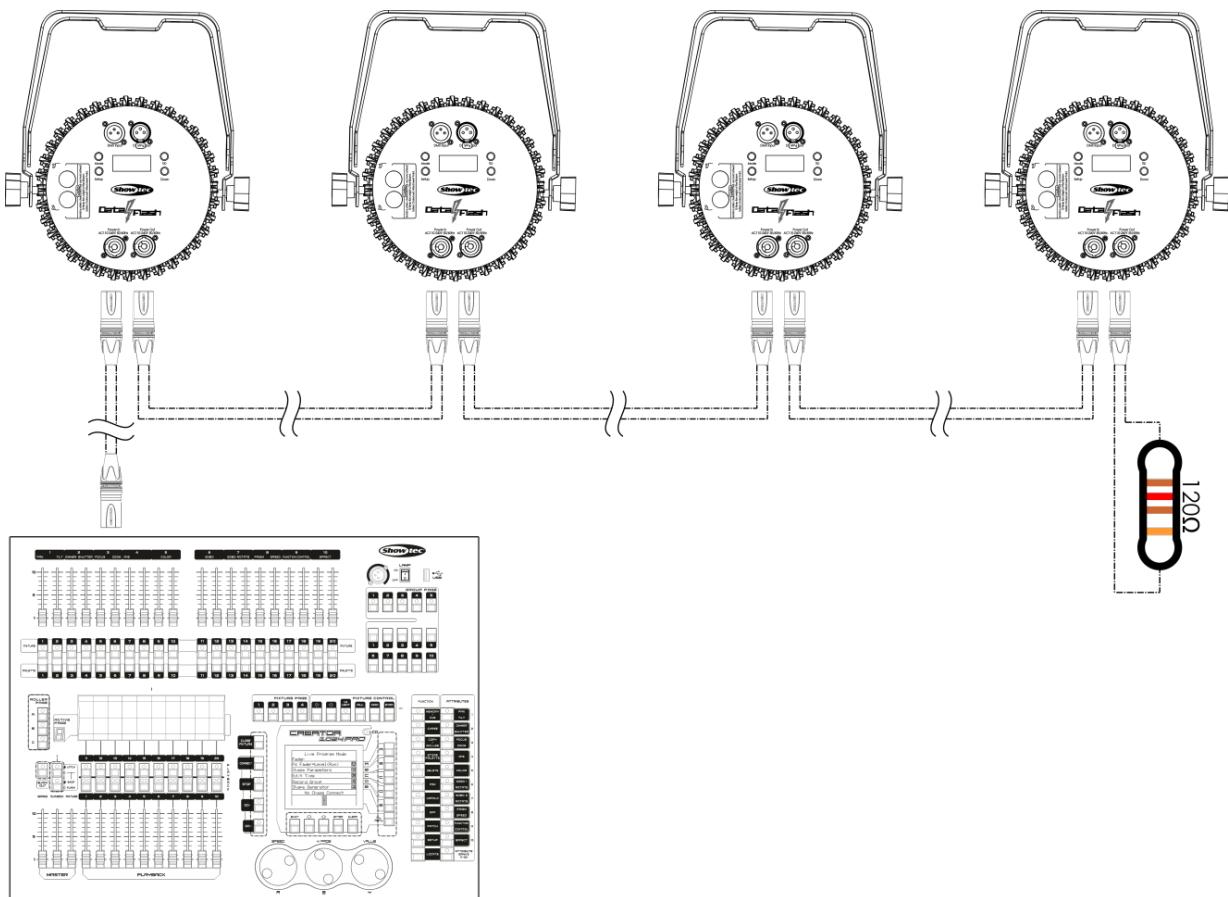

Fig. 04

Note : Link all cables before connecting electric power

Fixture Linking

You will need a serial data link to run light shows of one or more fixtures using a DMX-512 controller or to run synchronized shows of two or more fixtures set to a master/slave operating mode. The combined number of channels required by all the fixtures on a serial data link determines the number of fixtures the data link can support.

Important: Fixtures on a serial data link must be daisy-chained in a single line. To comply with the EIA-485 standard, no more than 30 devices should be connected on one data link. Connecting more than 30 fixtures on one serial data link without the use of a DMX optically isolated splitter may result in deterioration of the digital DMX signal.



Maximum recommended DMX data link distance: 100 meters
Maximum recommended number of fixtures on a DMX data link: 30 fixtures

Data Cabling

To link fixtures together, you must obtain data cables. You can purchase DAP Audio certified DMX cables directly from a dealer/distributor or construct your own cable. If you choose to create your own cable, please use data-grade cables that can carry a high quality signal and are less prone to electromagnetic interference.

DAP Audio DMX Data Cables

- DAP Audio Basic microphone cable for allround use. bal. XLR/M 3-pin > XLR/F 3-pin. **Ordercode** FL01150 (1,5 m), FL013 (3 m), FL016 (6 m), FL0110 (10 m), FL0115 (15 m), FL0120 (20 m).
- DAP Audio X-type data cable XLR/M 3-pin > XLR/F 3-pin. **Ordercode** FLX0175 (0,75 m), FLX01150 (1,5 m), FLX013 (3 m), FLX016 (6 m), FLX0110 (10 m).
- DAP Audio cable for the demanding user with exceptional audio-qualities and connector made by Neutrik®. **Ordercode** FL71150 (1,5 m), FL713 (3 m), FL716 (6 m), FL7110 (10 m).
- DAP Audio cable for the demanding user with exceptional audio-qualities and connector made by Neutrik®. **Ordercode** FL7275 (0,75 m), FL72150 (1,5 m), FL723 (3 m), FL726 (6 m), FL7210 (10 m).
- DAP Audio 110 Ohm cable with digital signal transmission. **Ordercode** FL0975 (0,75 m), FL09150 (1,5 m), FL093 (3 m), FL096 (6 m), FL0910 (10 m), FL0915 (15 m), FL0920 (20 m).
- DAP Audio DMX adapter: 3-pin/5-pin. **Ordercode** FLA30.

The Data Flash Strobe can be operated with a controller in DMX mode or without the controller in stand-alone mode.

Control Panel

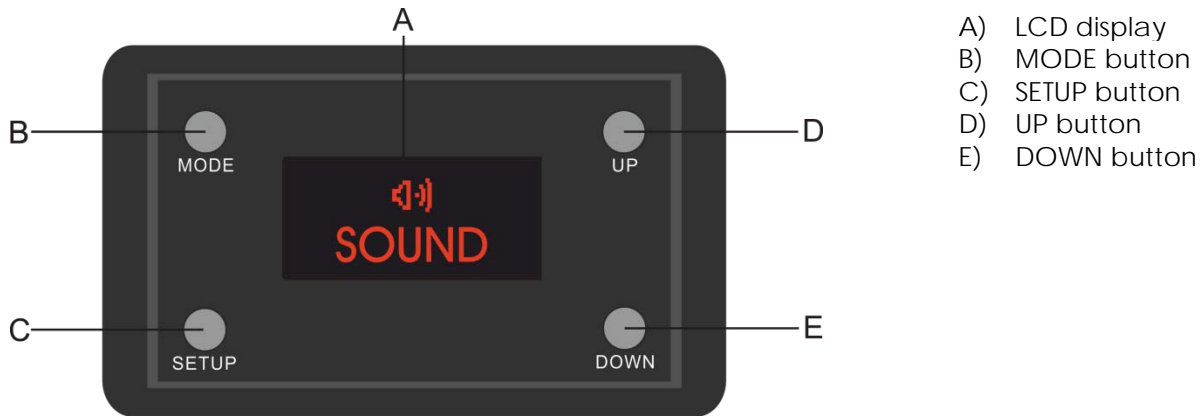

Fig. 05

Control Mode

The fixtures are individually addressed on a data-link and connected to the controller. The fixtures respond to the DMX signal from the controller. (When you select the DMX address and save it, the controller will display the saved DMX address, next time.)

DMX Addressing

The control panel on the front side of the base allows you to assign DMX fixture addresses, which is the first channel with which the Data Flash Strobe will respond to the controller.

Please note, when you use the controller, the unit has **12** channels.

When using multiple Data Flash Strobes, make sure you set the DMX addresses right.

Therefore, the DMX address of the first Data Flash Strobe should be **1(001)**; the DMX address of the second Data Flash Strobe should be **1+12=13 (013)**; the DMX address of the third Data Flash Strobe should be **13+12=25 (025)**, etc. Please, be sure that you do not have any overlapping channels in order to control each Data Flash Strobe correctly. If two or more Data Flash Strobes are addressed similarly, they will work similarly.

Controlling:

After having addressed all Data Flash Strobe fixtures, you may now start operating these via your lighting controller.

Note: After switching on, the Data Flash Strobe will automatically detect whether DMX 512 data is received or not. If there is no data received at the DMX-input, the "LED" on the control panel will not flash.

If not, the problem may be:

- The XLR cable from the controller is not connected with the input of the Data Flash Strobe.
- The controller is switched off or defective, the cable or connector is defective, or the signal wires are swapped in the input connector.

Note: It is necessary to insert an XLR termination plug (with 120 Ohm) in the last fixture in order to ensure proper transmission on the DMX data link.







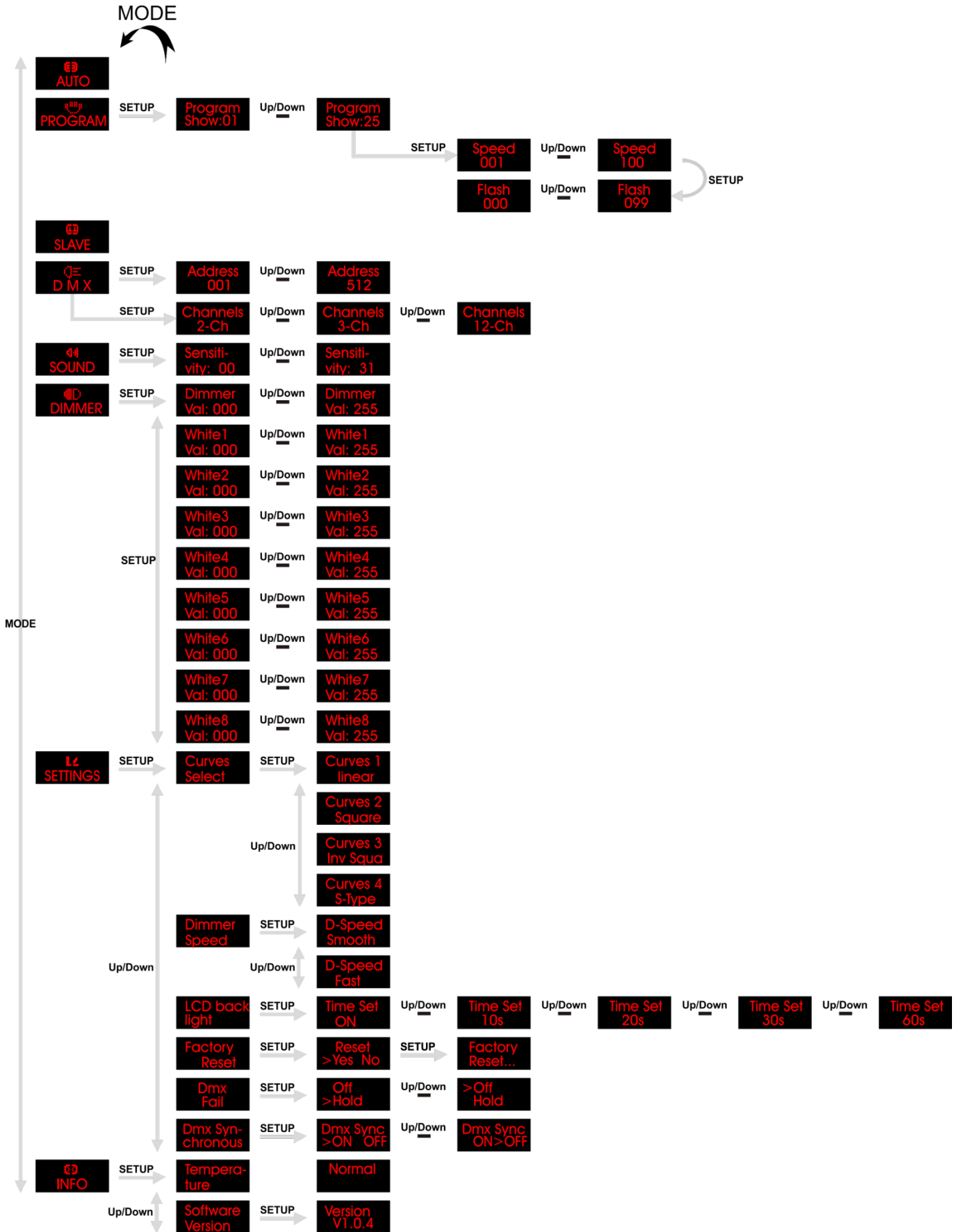

Display Off after 60 seconds

It is possible to set a time for turning off the display. When no button is pressed for 10, 20, 30 or 60 seconds, the display will turn off. To light up the display, you have to press the MODE, SETUP, UP or DOWN buttons. Once you have pressed the button, the display will light up.

Menu Overview



Main Menu Options

-  1. Auto run
-  2. Built in programs
-  3. Slave mode
-  4. DMX addressing
-  5. Sound-controlled mode
-  6. Dimmer options
-  7. Settings
-  8. Info

On start-up, the device will show the current software version:







1. Auto Run Mode

With this menu you can start Auto Run mode.

- 01) Press the **MODE** button and then the **UP/DOWN** buttons, until the display shows .
- 02) The Data Flash Strobe will now run all the built-in programs in a sequence.

2. Built-in Programs

With this menu you can you can set the built-in programs.

- 01) Press the **MODE** button and then the **UP/DOWN** buttons, until the display shows .
- 02) Press the **SETUP** button to open the menu.
- 03) Press the **UP/DOWN** buttons to toggle through the 25 built-in programs.
- 04) Once you have selected one of the programs   , press the **SETUP** button to open the program.
- 05) Press the **SETUP** button several times to toggle between strobe frequency and program speed settings.
- 06) Press the **UP/DOWN** buttons to change the values.

   Program speed, from 001-100

   Strobe frequency, from 00-99









3. Slave Mode

With this menu you can set the device as a slave.

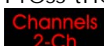

- 01) Press the **MODE** button and then the **UP/DOWN** buttons, until the display shows .
- 02) If the device has not been set to slave, it is automatically classified as a master device. All slave devices will follow the master. If the device has been set to slave, it will react the same as its master device.

4. DMX Addressing

With this menu you can set the DMX address and control the DMX configuration.

- 01) Press the **MODE** button and then the **UP/DOWN** buttons, until the display shows  DMX.
- 02) Press the **SETUP** button to open the menu. You can choose 512 different DMX addresses.
- 03) Press the **UP/DOWN** buttons to select the required address from   . Once you have set the desired DMX address, you can also see the DMX mode.
- 04) Press the **SETUP** button again to proceed to the channel mode settings.
- 05) Press the **UP/DOWN** buttons to choose one of the 3 channel modes. The available options are     .

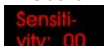
5. Sound control Mode

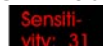
- 01) Press the **MODE** button and then the **UP/DOWN** buttons, until the display shows  SOUND.
- 02) Press the **SETUP** button to open the menu.
- 03) Press the **UP/DOWN** buttons to set the sound sensitivity. The adjustment range is between   , from OFF to high sound sensitivity.

6. Dimmer

With this menu you can display the 8 sections of the device at once, or choose one or multiple sections.

- 01) Press the **MODE** button and then the **UP/DOWN** buttons, until the display shows  DIMMER.
- 02) Press the **SETUP** button to open the menu.
- 03) Press the **SETUP** button to toggle through the menu and choose the desired sections.

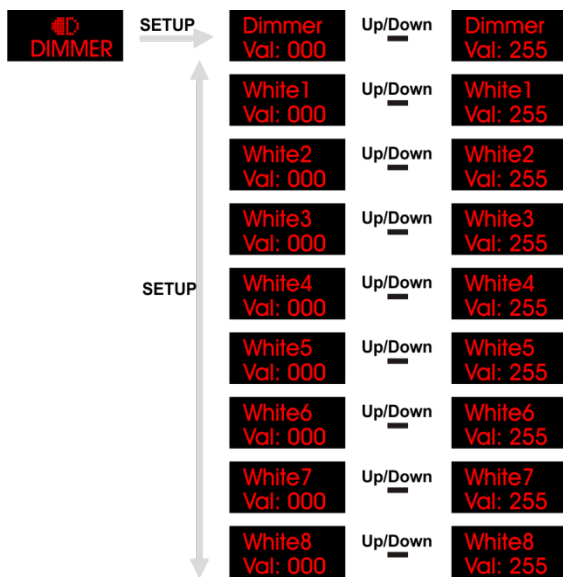

- 04) Set the intensity of the sections by pressing the **UP/DOWN** buttons.
- 05) Be aware of the fact that, in order to display a section, you will have to set the **Dimmer** value (000-255).

7. Settings

- 01) Press the **MODE** button and then the **UP/DOWN** buttons, until the display shows **SETTINGS**.
- 02) Press the **SETUP** button to open the menu.





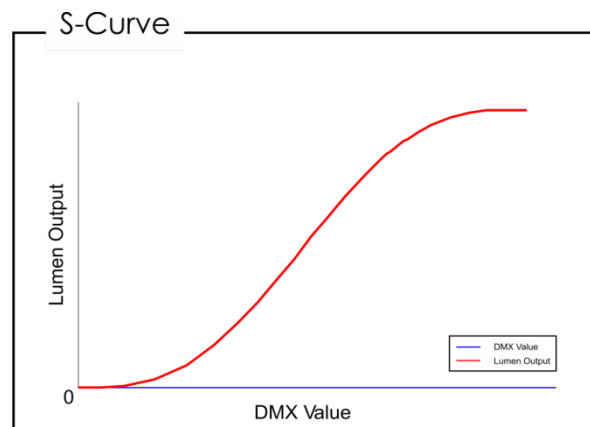
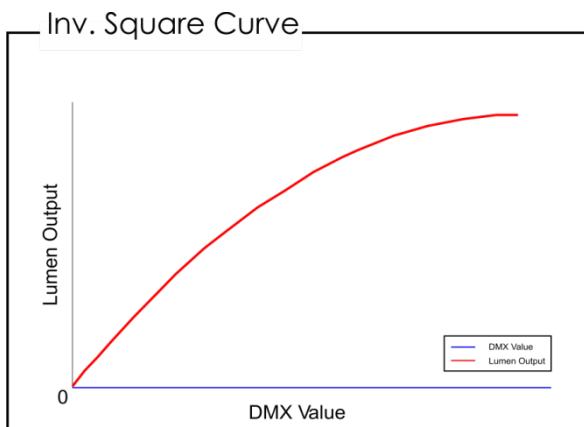
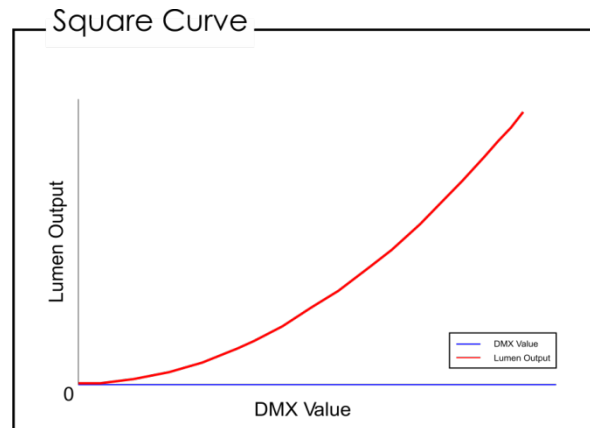
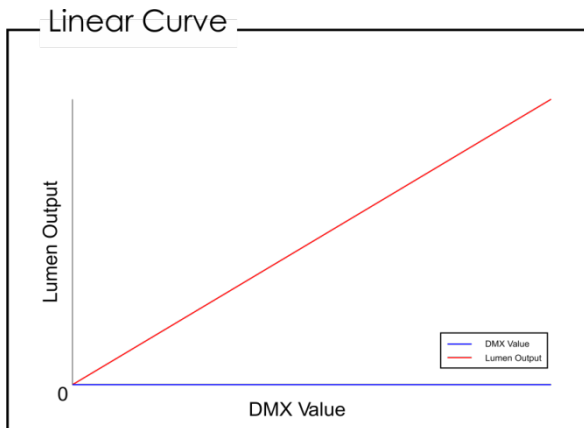

- 03) Press the **UP/DOWN** buttons to choose between the 6 available options, **Curves Select**, **Dimmer Speed**, **LCD back light**, **Factory Reset**, **Dmx Fail** and **Dmx Synchronous**.
- 04) Press the **SETUP** button to open one of the 6 options.

05) In menu **Curves Select** you can select one of the 4 dimming curves, by pressing the **UP/DOWN** buttons.



- 06) With the menu **Dimmer Speed**, you can set the dimmer speed, by pressing the **UP/DOWN** buttons. You can choose Smooth or Fast.
- 07) In the menu **LCD back light** you can set how long the display will remain ON, when no button is pressed.
- 08) Press the **UP/DOWN** buttons to choose between 10, 20, 30 or 60 seconds. If you choose the option "ON", the display will remain continuously ON, when no button is pressed.
- 09) The last option **Factory Reset** is for resetting the device to the factory settings.
- 10) Press the **SETUP** button to open the menu and then press the **UP/DOWN** buttons to choose Yes or No.
- 11) Press the **SETUP** button again to confirm your choice. If you have chosen Yes, the factory settings will be restored.
- 12) In the menu **Dmx Fail** you can set the device's behavior in case of a DMX signal error.
- 13) Press the **SETUP** button to open the menu and then press the **UP/DOWN** buttons to choose Off or Hold. If you have chosen Off, the device will black out. If you have chosen Hold, the device will use the last properly received DMX signal until DMX connection is restored.
- 14) Press the **SETUP** button to confirm your choice.
- 15) In the menu **Dmx Synchronous** you can set synchronous DMX.
- 16) Press the **SETUP** button to open the menu and then press the **UP/DOWN** buttons to choose On or Off.
- 17) Press the **SETUP** button to confirm your choice.

8. Info

- 01) Press the **MODE** button and then the **UP/DOWN** buttons, until the display shows .
- 02) Press the **SETUP** button to open the menu.
- 03) Press the **UP/DOWN** buttons to choose between the 2 options,  and .
- 04) Press the **SETUP** button to open one of the 2 options.
- 05) In the menu , the device will display if the temperature from the device is too high or not.
- 06) In the menu  you can view the current software version.

DMX Channels

2 channels

Channel 1 – Dimmer intensity

0-255	Gradual adjustment, from dark to brightest 0-100%
-------	---

Channel 2 – Strobe (Dimmer must be open)

0-4	Closed
5-127	Linear strobe, from low to high frequency (0-20Hz) ALL LEDs
128-189	Random strobe, from low to high frequency ALL LEDs
190-255	Random strobe RANDOM LED RINGS

3 channels

Channel 1 – Dimmer intensity

0-255	Gradual adjustment, from dark to brightest 0-100%
-------	---

Channel 2 – Strobe (Dimmer and CH3 must be open)

0-4	Closed
5-255	Strobe flash frequency, from low to high frequency (0-20 Hz)

Channel 3 – Strobe mode (Dimmer and CH2 must be open)

0-127	Linear strobe, from low to high frequency (0-20Hz) ALL LEDs
128-149	Random strobe, from low to high frequency ALL LEDs
150-172	Random strobe RANDOM LED RINGS
173-199	Blinder mode (25Hz) ALL LEDs
200-231	Sound sensitivity, from OFF to high sensitivity
232-255	Single flash mode

12 channels

Channel 1 – Dimmer intensity

0-255 Gradual adjustment, from dark to brightest 0-100%

Channel 2 – Section 1 (⚠ Dimmer must be open ⚠)

0-255 Gradual adjustment section 1, from dark to brightest 0-100%

Channel 3 – Section 2 (⚠ Dimmer must be open ⚠)

0-255 Gradual adjustment section 2, from dark to brightest 0-100%

Channel 4 – Section 3 (⚠ Dimmer must be open ⚠)

0-255 Gradual adjustment section 3, from dark to brightest 0-100%

Channel 5 – Section 4 (⚠ Dimmer must be open ⚠)

0-255 Gradual adjustment section 4, from dark to brightest 0-100%

Channel 6 – Section 5 (⚠ Dimmer must be open ⚠)

0-255 Gradual adjustment section 5, from dark to brightest 0-100%

Channel 7 – Section 6 (⚠ Dimmer must be open ⚠)

0-255 Gradual adjustment section 6, from dark to brightest 0-100%

Channel 8 – Section 7 (⚠ Dimmer must be open ⚠)

0-255 Gradual adjustment section 7, from dark to brightest 0-100%

Channel 9 – Section 8 (⚠ Dimmer must be open ⚠)

0-255 Gradual adjustment section 8, from dark to brightest 0-100%

Channel 10 – Built-in Programs (⚠ Dimmer and dimmer speed must be open ⚠)

1-9 Program 01

10-19 Program 02

20-29 Program 03

30-39 Program 04

40-49 Program 05

50-59 Program 06

60-69 Program 07

70-79 Program 08

80-89 Program 09

90-99 Program 10

100-109 Program 11

110-119 Program 12

120-129 Program 13

130-139 Program 14

140-149 Program 15

150-159 Program 16

160-169 Program 17

170-179 Program 18

180-189 Program 19

190-199 Program 20

200-209 Program 21

210-219 Program 22

220-229 Program 23

230-239	Program 24
240-249	Program 25
250-255	Sound-controlled

Channel 11 – Dimmer speed (⚠ Dimmer must be open ⚠)

0-255	From slow to fast
250-255	Sound sensitivity 0-31, from low to high sensitivity (CH10 must be set between 250-255)

Channel 12 – Strobe (⚠ Dimmer must be open ⚠)

0-4	Closed
5-255	Strobe flash frequency, from low to high (0-20 Hz)

Maintenance

The operator has to make sure that safety-related and machine-technical installations are to be inspected by an expert after every year in the course of an acceptance test.

The operator has to make sure that safety-related and machine-technical installations are to be inspected by a skilled person once a year.

The following points have to be considered during the inspection:

- 01) All screws used for installing the device or parts of the device have to be tightly connected and must not be corroded.
- 02) There may not be any deformations on housings, fixations and installation spots.
- 03) Mechanically moving parts like axles, eyes and others may not show any traces of wearing.
- 04) The electric power supply cables must not show any damages or material fatigue.

The Data Flash Strobe requires almost no maintenance. However, you should keep the unit clean.

Otherwise, the fixture's light output will be significantly reduced. Disconnect the mains power supply, and then wipe the cover with a damp cloth. Do not immerse in liquid. Wipe lens clean with glass cleaner and a soft cloth. Do not use alcohol or solvents.

The front lens will require weekly cleaning, as smoke-fluid tends to build up residues, reducing the light-output very quickly.

Keep connections clean. Disconnect electric power, and then wipe the DMX and audio connections with a damp cloth. Make sure connections are thoroughly dry before linking equipment or supplying electric power.

Troubleshooting

This troubleshooting guide is meant to help solve simple problems.

If a problem occurs, carry out the steps below in sequence until a solution is found. Once the unit operates properly, do not carry out following steps.

No Light

If the light effect does not operate properly, refer servicing to a technician.

Suspect two potential problem areas as: the power supply, the LEDs.

- 01) Power supply. Check that the unit is plugged into an appropriate power supply.
- 02) The LEDs. Return the Data Flash Strobe to your Showtec dealer.
- 03) If all of the above appears to be O.K., plug the unit in again.
- 04) If you are unable to determine the cause of the problem, do not open the Data Flash Strobe, as this may damage the unit and the warranty will become void.
- 05) Return the device to your Showtec dealer.

No Response to DMX

Suspect the DMX cable or connectors, a controller malfunction, a light effect DMX card malfunction.

- 01) Check the DMX setting. Make sure that DMX addresses are correct.
- 02) Check the DMX cable: Unplug the unit; change the DMX cable; then reconnect to electrical power. Try your DMX control again.

03) Determine whether the controller or light effect is at fault. Does the controller operate properly with other DMX products? If not, take the controller in for repair. If so, take the DMX cable and the light effect to a qualified technician.

Problem	Probable cause(s)	Solution
One or more fixtures do not function at all	No power to the fixture	<ul style="list-style-type: none"> Check if power is switched on and cables are plugged in
Fixtures reset correctly, but all respond erratically or not at all to the controller	The controller is not connected.	<ul style="list-style-type: none"> Connect controller.
	3-pin XLR Out of the controller does not match XLR Out of the first fixture on the link (i.e. signal is reversed)	<ul style="list-style-type: none"> Install a phase reversing cable between the controller and the first fixture on the link
Fixtures reset correctly, but some respond erratically or not at all to the controller	Poor data quality	<ul style="list-style-type: none"> Check data quality. If much lower than 100 percent, the problem may be a bad data link connection, poor quality or broken cables, missing termination plug, or a defective fixture disturbing the link
	Bad data link connection	<ul style="list-style-type: none"> Inspect connections and cables. Correct poor connections. Repair or replace damaged cables
	Data link not terminated with 120 Ohm termination plug	<ul style="list-style-type: none"> Insert termination plug in output jack of the last fixture on the link
	Incorrect addressing of the fixtures	<ul style="list-style-type: none"> Check address setting
	One of the fixtures is defective and disturbs data transmission on the link	<ul style="list-style-type: none"> Bypass one fixture at a time until normal operation is restored: unplug both connectors and connect them directly together. Have the defective fixture serviced by a qualified technician
	3-pin XLR Out on the fixtures does not match (pins 2 and 3 reversed)	<ul style="list-style-type: none"> Install a phase-reversing cable between the fixtures or swap pin 2 and 3 in the fixture that behaves erratically
No light or LEDs cut out intermittently	Fixture is too hot	<ul style="list-style-type: none"> Allow the fixture to cool down Make sure air vents in control panel and the front lens are not blocked Turn up the air conditioning
	LEDs damaged	<ul style="list-style-type: none"> Disconnect the fixture and return it to your dealer
	The power supply settings do not match local AC voltage and frequency	<ul style="list-style-type: none"> Disconnect fixture. Check settings and correct if necessary

Product Specifications

Model:	Showtec Data Flash Strobe
Input Voltage:	110-240V AC, 50/60Hz
Power consumption:	120W (full output)
DMX linking:	30 pcs
Protection rate:	IP-20
Dimensions:	263 x 83 x 293 mm (LxWxH)
Weight:	2,6 kg
Operating and Programming:	
Signal pin OUT:	Pin 1 (earth), pin 2 (-), pin 3 (+)
DMX Mode:	2, 3, 12 channels
Signal input:	3-pin DMX IN
Signal output:	3-pin DMX OUT
Electro-mechanical effects:	
Light source:	SMD LEDs
Dimmer:	0-100%
Strobe:	0-20Hz
Housing:	Aluminum
DMX-control:	via standard DMX-controller (DMX-512)
On Board:	LCD display for easy setup
Control:	Auto, Built-in Programs, Sound-controlled, Master/Slave, DMX
Connections:	Pro power (Blue/Gray) & 3-pin XLR IN & OUT
Cooling:	Convection
Protection rate:	IP20
Max. ambient temperature t_a :	40°C
Max. housing temperature t_B :	80°C
Minimum distance:	
Minimum distance from flammable surfaces:	0,5 m
Minimum distance to lighted object:	1 m

Design and product specifications are subject to change without prior notice.



Website: www.Showtec.info

Email: service@highlite.nl

Dimensions

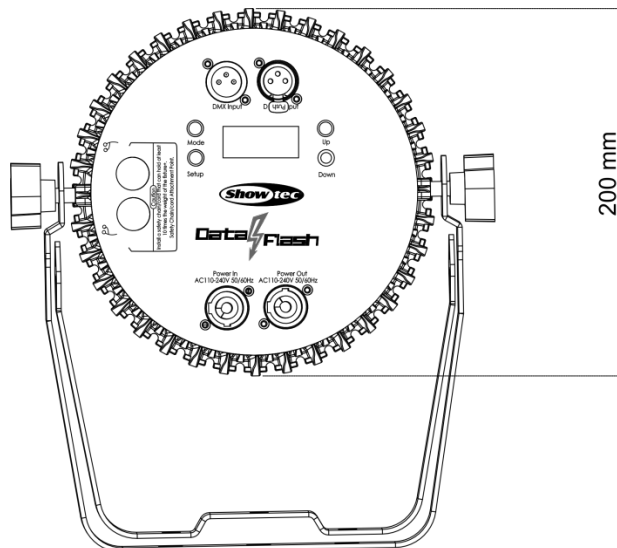
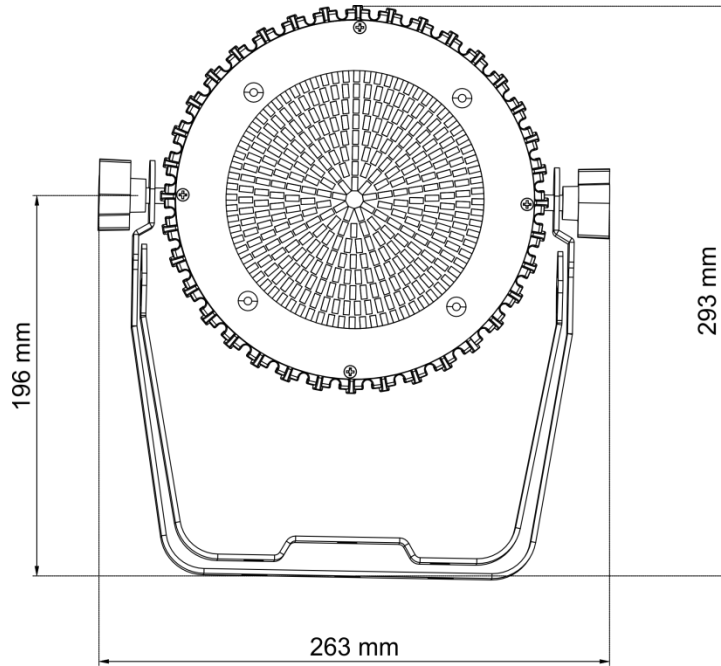



©2016 Showtec