

**ENGLISH**

**Infinity iW-741 RDM**

**V1**

**Ordercode: 41528**

## Table of contents

<b>Warning</b> .....	2
Safety Instructions .....	2
Operating Determinations .....	4
Rigging .....	4
Connection with the mains.....	5
Return Procedure.....	6
Claims.....	6
<b>Description of the device</b> .....	7
Optional accessories.....	7
Overview .....	8
Backside .....	9
<b>Installation</b> .....	9
<b>Set Up and Operation</b> .....	9
Control Modes.....	10
One Infinity (Built-in Programs).....	10
Multiple Infinity's (Master/Slave control) .....	10
Multiple Infinity's (DMX Control) .....	11
Fixture Linking.....	12
Data Cabling.....	12
Control Panel.....	13
Control Mode .....	13
DMX Addressing.....	13
Menu Overview.....	14
Main Menu Options.....	15
1. DMX Address .....	15
2. Edit Mode .....	16
3. Settings Menu .....	17
3.1. Color Balance .....	17
3.2. Life Time .....	18
3.2.1. Set Password .....	18
3.3. Reset Functions .....	18
4. Built-in Programs.....	19
5. Test Menu .....	20
6. Information Menu .....	21
DMX Channels .....	22
20 Channels .....	22
15 Channels .....	25
<b>Maintenance</b> .....	27
Replacing a Fuse .....	27
<b>Troubleshooting</b> .....	28
No Light .....	28
No Response to DMX.....	28
<b>Product Specifications</b> .....	30
Dimensions .....	31
Notes.....	32

## Warning



**For your own safety, please read this user manual carefully  
before your initial start-up!**



### Unpacking Instructions

Immediately upon receiving this product, carefully unpack the carton and check the contents to ensure that all parts are present, and have been received in good condition. Notify the dealer immediately and retain packing material for inspection if any parts appear damaged from shipping or the carton itself shows signs of mishandling. Save the carton and all packing materials. In the event that a fixture must be returned to the factory, it is important that the fixture be returned in the original factory box and packing.

### Your shipment includes:

- Infinity iW-741 RDM with PowerCON cable (1,4 m)
- 1 bracket for truss mounting
- User manual

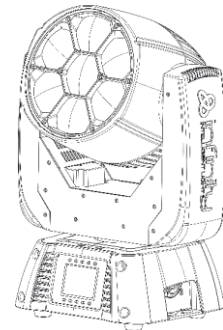
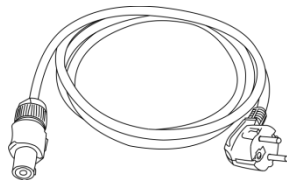

### LED Expected Lifespan

LEDs gradually decline in brightness over time. HEAT is the dominant factor that leads to the acceleration of this decline. Packaged in clusters, LEDs exhibit higher operating temperatures than in ideal or singular optimum conditions. For this reason when all color LEDs are used at their fullest intensity, life of the LEDs is significantly reduced. If improving your lifespan expectancy is of a higher priority, place care in providing for lower operational temperatures. This may include climatic-environmental and the reduction of overall projection intensity.



### CAUTION!

**Keep this device away from rain and moisture!  
Unplug mains lead before opening the housing!**



### Safety Instructions

Every person involved with the installation, operation and maintenance of this device has to:

- be qualified
- follow the instructions of this manual



**CAUTION! Be careful with your operations.  
With a dangerous voltage you can suffer  
a dangerous electric shock when touching the wires!**



Before your initial start-up, please make sure that there is no damage caused by transportation. Should there be any, consult your dealer and do not use the device.

To maintain perfect condition and to ensure a safe operation, it is absolutely necessary for the user to follow the safety instructions and warning notes written in this manual.

Please consider that damages caused by manual modifications to the device are not subject to warranty.

This device contains no user-serviceable parts. Refer servicing to qualified technicians only.

### **IMPORTANT:**

The manufacturer will not accept liability for any resulting damages caused by the non-observance of this manual or any unauthorized modification to the device.

- Never let the power cord come into contact with other cables! Handle the power cord and all connections with the mains with particular caution!
- Never remove warning or informative labels from the unit.
- Never use anything to cover the ground contact.
- Never lift the fixture by holding it at the projector-head, as the mechanics may be damaged. Always hold the fixture at the transport handles.
- Never place any material over the lens.
- Never look directly into the light source.
- Never leave any cables lying around.
- Do not insert objects into air vents.
- Do not connect this device to a dimmer pack.
- Do not switch the device on and off in short intervals, as this would reduce the device's life.
- Do not touch the device's housing bare-handed during its operation (housing becomes very hot). Allow the fixture to cool for at least 5 minutes before handling.
- Do not shake the device. Avoid brute force when installing or operating the device.
- Only use device indoors, avoid contact with water or other liquids.
- Only operate the fixture after having checked that the housing is firmly closed and all screws are tightly fastened.
- Only operate the device after having familiarized with its functions.
- Avoid flames and do not put close to flammable liquids or gases.
- Always keep case closed while operating.
- Always allow free air space of at least 50 cm around the unit for ventilation.
- Always disconnect power from the mains, when device is not used or before cleaning! Only handle the power cord by the plug. Never pull out the plug by tugging the power cord.
- Make sure that the device is not exposed to extreme heat, moisture or dust.
- Make sure that the available voltage is not higher than stated on the rear panel.
- Make sure that the power cord is never crimped or damaged. Check the device and the power cord from time to time.
- If the lens is obviously damaged, it has to be replaced, so that its functions are not impaired due to cracks or deep scratches.
- If device is dropped or struck, disconnect mains power supply immediately. Have a qualified engineer inspect for safety before operating.
- If the device has been exposed to drastic temperature fluctuation (e.g. after transportation), do not switch it on immediately. The arising condensation water might damage your device. Leave the device switched off until it has reached room temperature.
- If your Infinity device fails to work properly, discontinue use immediately. Pack the unit securely (preferably in the original packing material), and return it to your Infinity dealer for service.
- For adult use only. Moving head must be installed out of the reach of children. Never leave the unit running unattended.
- Never attempt to bypass the thermostatic switch or fuses.
- For replacement use fuses of same type and rating only.
- The user is responsible for correct positioning and operating of the Infinity. The manufacturer will not accept liability for damages caused by the misuse or incorrect installation of this device.
- This device falls under protection class I. Therefore it is essential to connect the yellow/green conductor to earth.
- Repairs, servicing and electric connection must be carried out by a qualified technician.
- **WARRANTY:** Till one year after date of purchase.



**CAUTION! Eyedamages!!!**  
**Avoid looking directly into the lightsource!!!**  
**(meant especially for epileptics)!!!**



**Operating Determinations**

- This device is not designed for permanent operation. Consistent operation breaks will ensure that the device will serve you for a long time without defects.
- The minimum distance between light-output and the illuminated surface must be more than 1 meter.
- To eliminate wear and improve lifespan, during periods of non-use, completely disconnect from power via breaker or by unplugging.
- The maximum ambient temperature  $t_a = 40^{\circ}\text{C}$  must never be exceeded.
- The relative humidity must not exceed 50 % with an ambient temperature of  $40^{\circ}\text{C}$ .
- If this device is operated in any other way, than the one described in this manual, the product may suffer damages and the warranty becomes void.
- Any other operation may lead to dangers like short-circuit, burns, electric shock, crash etc.

*You endanger your own safety and the safety of others!*

**Rigging**

*Please follow the European and national guidelines concerning rigging, trussing and all other safety issues.*

*Do not attempt the installation yourself !*

*Always let the installation be carried out by an authorized dealer !*

**Procedure:**

- If the Infinity is lowered from the ceiling or high joists, professional trussing systems have to be used.
- Use a clamp to mount the Infinity, with the mounting-bracket, to the trussing system.
- The Infinity must never be fixed swinging freely in the room.
- The installation must always be secured with a safety attachment, e.g. an appropriate safety net or safety-cable.
- When rigging, derigging or servicing the Infinity, always make sure, that the area below the installation place is blocked and staying in the area is forbidden.

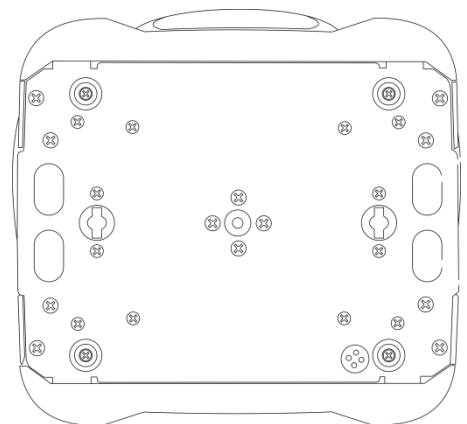
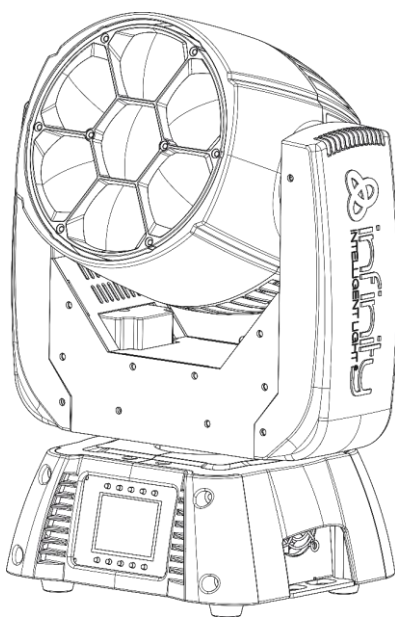

The Infinity can be placed on a flat stage floor or mounted to any kind of truss with a clamp.

**Mounting a clamp to the underside of the Infinity moving head**

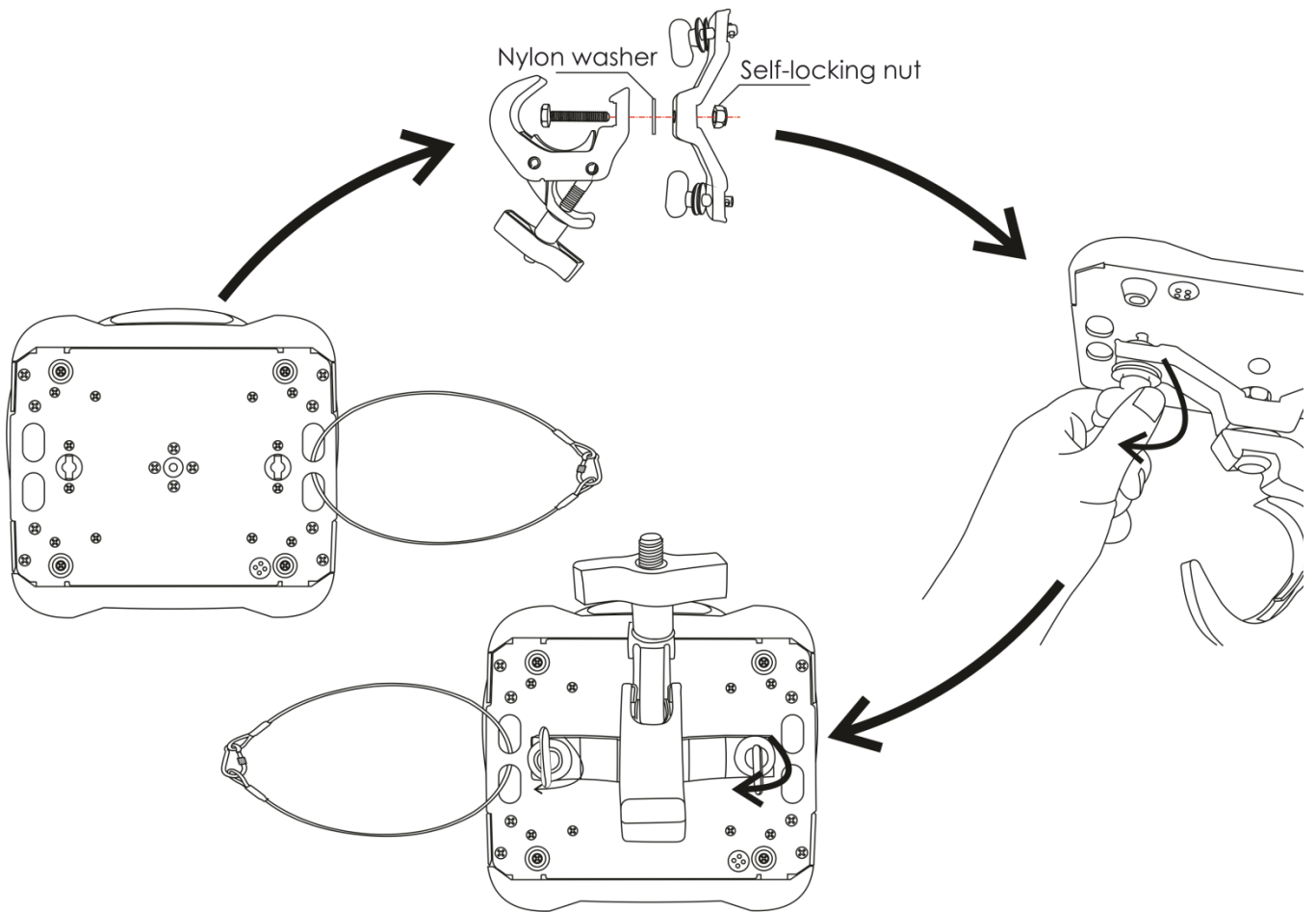

*Improper installation can cause serious injuries and/or damage of property !*

**Connection with the mains**

Connect the device to the mains with the power-plug.

Always pay attention, that the right color cable is connected to the right place.

International	EU Cable	UK Cable	US Cable	Pin
L	BROWN	RED	YELLOW/COPPER	FASE
N	BLUE	BLACK	SILVER	NULL
⊕	YELLOW/GREEN	GREEN	GREEN	EARTH

*Make sure that the device is always connected properly to the earth!*



### **Return Procedure**

Returned merchandise must be sent prepaid and in the original packing, call tags will not be issued. Package must be clearly labeled with a Return Authorization Number (RMA number). Products returned without an RMA number will be refused. Highlite will not accept the returned goods or any responsibility. Call Highlite 0031-455667723 or mail [aftersales@highlite.com](mailto:aftersales@highlite.com) and request an RMA prior to shipping the fixture. Be prepared to provide the model number, serial number and a brief description of the cause of the return. Be sure to properly pack fixture as any shipping damage resulting from inadequate packaging is the customer's responsibility. Highlite reserves the right to use its own discretion to repair or replace product(s). As a suggestion, proper UPS packing or double-boxing is always a safe method to use.

**Note: If you are given an RMA number, please include the following information on a piece of paper inside the box:**

- 01) Your name.
- 02) Your address.
- 03) Your phone number.
- 04) A brief description of the symptoms.

### **Claims**

The client has the obligation to check the delivered goods immediately upon delivery for any shortcomings and/or visible defects, or perform this check after our announcement that the goods are at their disposal. Damage incurred in shipping is the responsibility of the shipper; therefore the damage must be reported to the carrier upon receipt of merchandise.

It is the customer's responsibility to notify and submit claims with the shipper in the event that the fixture is damaged due to shipping. Transportation damage has to be reported to us within one day after receipt of the delivery.

Any return shipment has to be made post-paid at all times. Return shipments must be accompanied with a letter defining the reason for return shipment. Non-prepaid return shipments will be refused, unless agreed otherwise in writing.

Complaints against us must be made known in writing or by fax within 10 working days after receipt of the invoice. After this period, complaints will not be handled anymore.

Complaints will only be considered if the client has so far complied with all parts of the agreement, regardless of the agreement of which the obligation is resulting.

## Description of the device

---

### Features

The Infinity iW-741 RDM is a wash moving head with high output and great effects.

- Ultrafast movements
- Selectable PWM rate by DMX
- Input voltage: 100-240V AC, 50/60Hz (auto ranging)
- Power consumption: 310W
- Light source: 7 x 40W RGBW 4-in-1 Osram
- Light output: 41888 Lux @ 3m
- Beam angle: 3,6°-60° motorized zoom
- Dimmer: 0-100%, 16 bit
- Strobe: 0-20Hz
- Dimmer curves: Linear, Square, Inv-Square, S curve
- Dimmer speed: Smooth, Fast
- Channel modes: 15, 20 channels
- Onboard: Battery powered full color display including gravity sensor
- Color balance: Separate RGBW adjustment
- Color mode: RGBW/CMY
- Control Protocol: DMX, RDM
- Pan / Tilt movement blackout, User-selectable Pan / Tilt ranges, 540°/360°/180° Reverse Pan / Tilt movement, Fan control (auto, full, silent)
- Pan 0°-540°
- Tilt 0°-230°
- Pan/Tilt resolution: 16 bit
- Control: DMX-512, Master/Slave, Built-in Programs
- Housing: Metal & flame-retardant plastic
- Color: Black
- Connections: 3-pin XLR data IN/OUT  
Neutrik PowerCON IN/OUT
- Wireless DMX: optional available
- Max. ambient temp: 45°
- Fuse: F5A/250V
- Dimensions: 290 x 204 x 418 mm (LxWxH)
- Weight: 9,36 kg

**Note:** Knowledge of DMX is required to fully utilize this unit.

### Optional accessories

**MOD41526** – Wireless DMX upgrade kit



**The Wireless DMX upgrade kit should be installed ONLY by a qualified technician.  
Do not attempt installation yourself!**





Overview

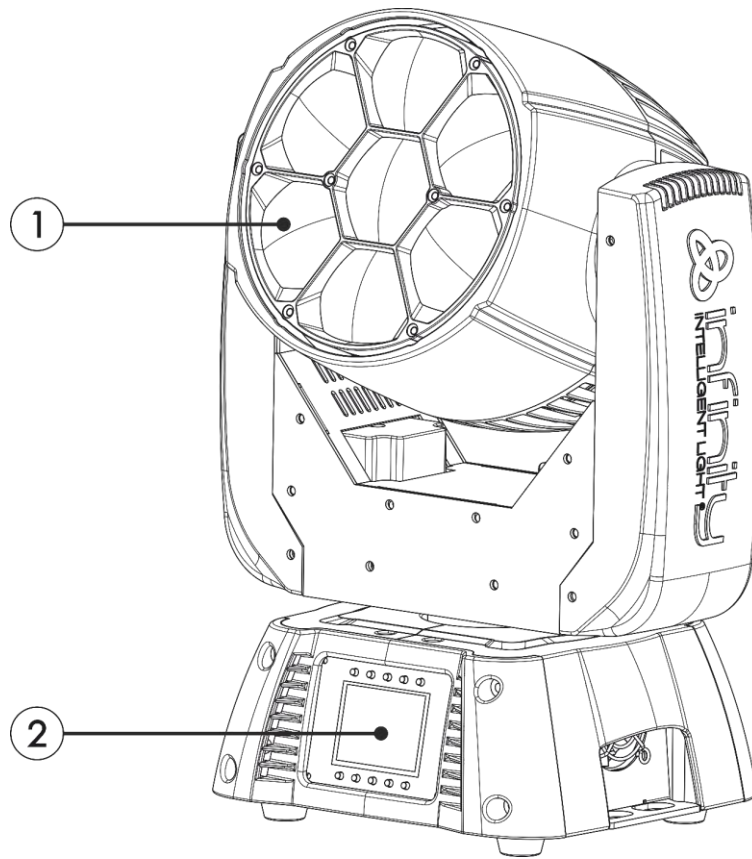
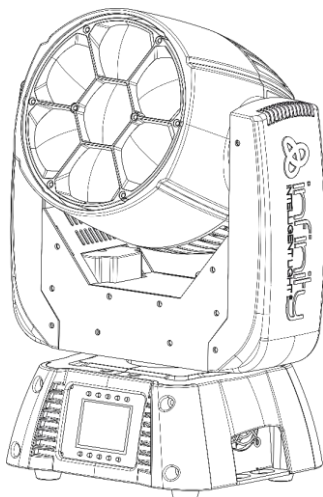
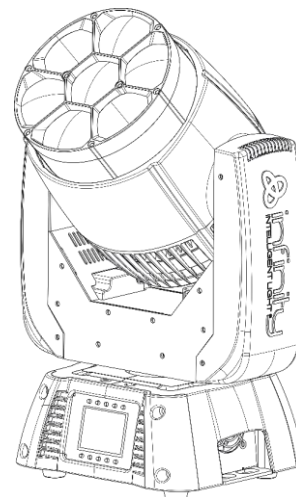

Fig. 01

- 01) 7 x 40W RGBW 4-in-1 Osram
- 02) Control buttons + LCD display



Beam angle 3,6°-Electronic adjustment



Beam angle 60°- Electronic adjustment

Fig. 02

## Backside

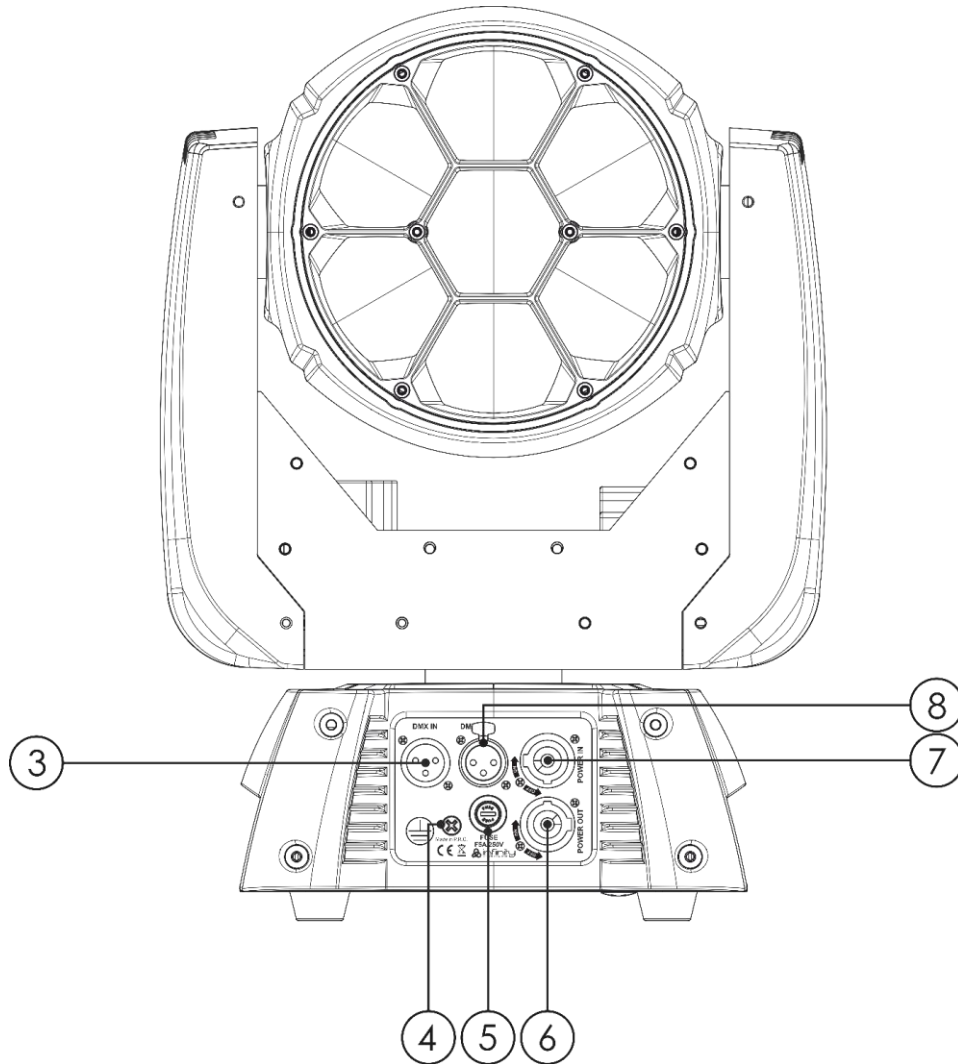

Fig. 03

- 03) 3-pin DMX signal connector IN
- 04) Ground/earth connection
- 05) Fuse F5A/250V
- 06) Neutrik PowerCON OUT (Gray)
- 07) Neutrik PowerCON IN (Blue)
- 08) 3-pin DMX signal connector OUT

## Installation

Remove all packing materials from the Infinity iW-741 RDM. Check that all foam and plastic padding is removed. Connect all cables.

**Do not supply power before the whole system is set up and connected properly.**

**Always disconnect from electric mains power supply before cleaning or servicing.**

**Damages caused by non-observance are not subject to warranty.**

## Set Up and Operation

Follow the directions below, as they pertain to your preferred operation mode.

Before plugging the unit in, always make sure that the power supply matches the product specification voltage. Do not attempt to operate a 120V specification product on 230V power, or vice versa.

## Control Modes

There are 3 modes:

- Stand-alone (built-in programs)
- Master/Slave
- DMX512 (15CH, 20CH)

### One Infinity (Built-in Programs)

- 01) Fasten the effect light onto firm trussing. Leave at least 1 meter on all sides for air circulation.
- 02) Always use a safety cable (ordercode 70140 / 70141).
- 03) Plug the end of the electric mains power cord into a proper electric power supply socket.
- 04) When the Infinity is not connected with a DMX cable, it functions as a stand-alone device.
- 05) Please see page 19 for more information about the built-in programs.

### Multiple Infinity's (Master/Slave control)

- 01) Fasten the effect light onto firm trussing. Leave at least 1 meter on all sides for air circulation.
- 02) Always use a safety cable (ordercode 70140 / 70141).
- 03) Plug the end of the electric mains power cord into a proper electric power supply socket.
- 04) Use a 3-pin XLR cable to connect the Infinity.

The pins:



1. Earth
2. Signal (-)
3. Signal (+)

- 05) Link the units as shown in fig. 04. Connect a DMX signal cable from the first unit's DMX "out" socket to the second unit's "in" socket. Repeat this process to link the second, third and fourth units. You can use the same functions on the master device as described on page 19 (Built-in Programs). This means that you can set your desired operation mode on the master device and all slave devices will react the same as the master device.

### Multiple Infinity's (Master/Slave control)

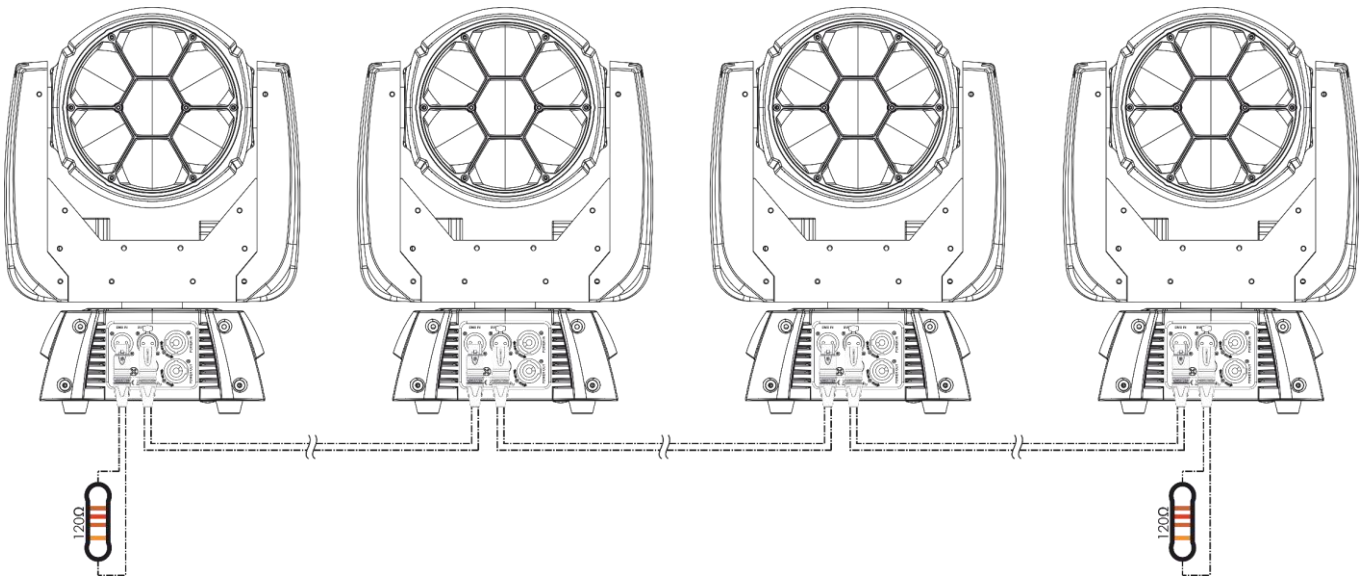
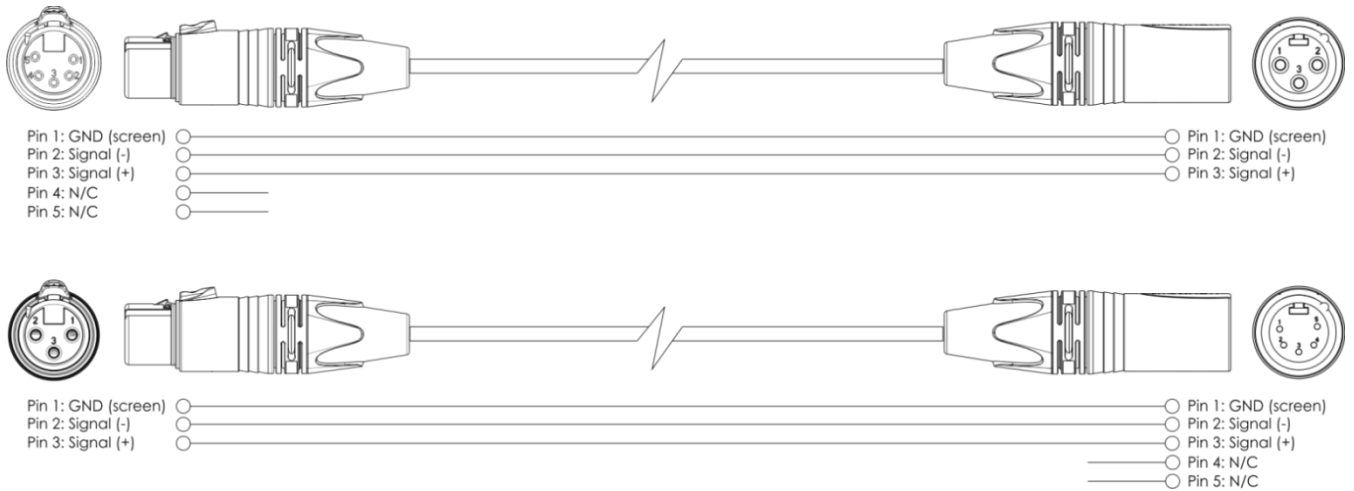

Fig. 04

## Multiple Infinity's (DMX Control)

- 01) Fasten the effect light onto firm trussing. Leave at least 1 meter on all sides for air circulation.
- 02) Always use a safety cable (ordercode 70140 / 70141).
- 03) Plug the end of the electric mains power cord into a proper electric power supply socket.
- 04) Use a 3-pin XLR cable to connect the Infinity's and other devices.



- 05) Link the units as shown in fig. 05. Connect a DMX signal cable from the first unit's DMX "out" socket to the second unit's "in" socket. Repeat this process to link the second, third and fourth units.
- 06) Supply electric power: Plug electric mains power cords into each unit's PowerCON socket, then plug the other end of the mains power cord into proper electric power supply sockets, starting with the first unit. Do not supply power before the whole system is set up and connected properly.

## Multiple Infinity's DMX Set Up

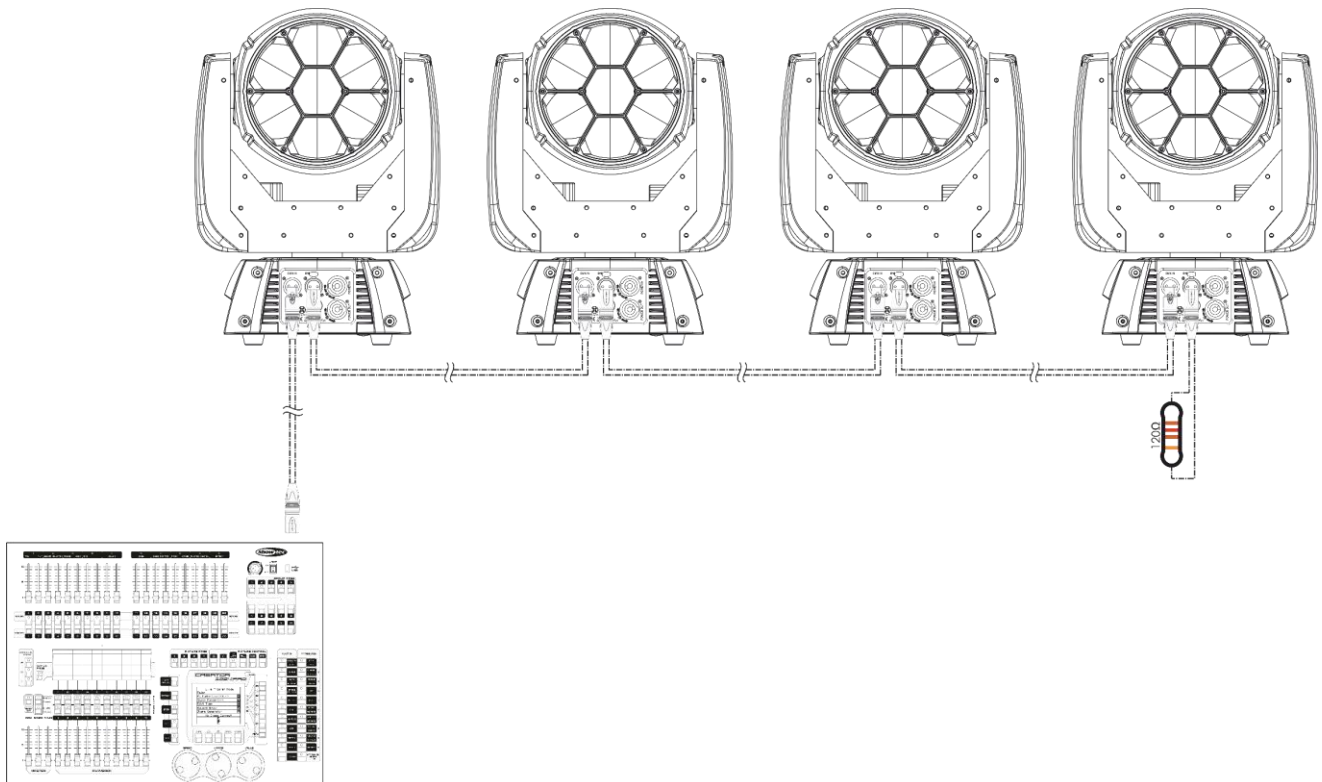



Fig. 05

**Note: Link all cables before connecting electric power**

## Fixture Linking

You will need a serial data link to run light shows of one or more fixtures using a DMX-512 controller or to run synchronized shows on two or more fixtures set to a master/slave operating mode. The combined number of channels required by all the fixtures on a serial data link determines the number of fixtures the data link can support.

**Important:** Fixtures on a serial data link must be daisy chained in one single line. To comply with the EIA-485 standard no more than 30 devices should be connected on one data link. Connecting more than 30 fixtures on one serial data link without the use of a DMX optically isolated splitter may result in deterioration of the digital DMX signal.

 Maximum recommended DMX data link distance: 100 meters  
 Maximum recommended number of fixtures on a DMX data link: 30 fixtures  
 Maximum recommended number of fixtures on a power link @120V: 3 fixtures  
 Maximum recommended number of fixtures on a power link @230V: 6 fixtures

## Data Cabling

To link fixtures together you must obtain data cables. You can purchase DAP Audio certified DMX cables directly from a dealer/distributor or construct your own cable. If you choose to create your own cable please use data-grade cables that can carry a high quality signal and are less prone to electromagnetic interference.

### DAP Audio DMX Data Cables

- DAP Audio Basic microphone cable for allround use. bal. XLR/M 3-pin > XLR/F 3-pin. **Ordercode** FL01150 (1,5 m), FL013 (3 m), FL016 (6 m), FL0110 (10 m), FL0115 (15 m), FL0120 (20 m).
- DAP Audio X-type data cable XLR/M 3-pin > XLR/F 3-pin. **Ordercode** FLX0175 (0,75 m), FLX01150 (1,5 m), FLX013 (3 m), FLX016 (6 m), FLX0110 (10 m).
- DAP Audio cable for the demanding user with exceptional audio-qualities and connector made by Neutrik®. **Ordercode** FL71150 (1,5 m), FL713 (3 m), FL716 (6 m), FL7110 (10 m).
- DAP Audio cable for the demanding user with exceptional audio-qualities and connector made by Neutrik®. **Ordercode** FL7275 (0,75 m), FL72150 (1,5 m), FL723 (3 m), FL726 (6 m), FL7210 (10 m).
- DAP Audio 110 Ohm cable with digital signal transmission. **Ordercode** FL0975 (0,75 m), FL09150 (1,5 m), FL093 (3 m), FL096 (6 m), FL0910 (10 m), FL0915 (15 m), FL0920 (20 m).
- DAP Audio DMX adapter: 3-pin/5-pin. **Ordercode** FLA30.

The Infinity iW-741 RDM can be operated with a controller in **control mode** or without the controller in **stand-alone mode**.

### Control Panel

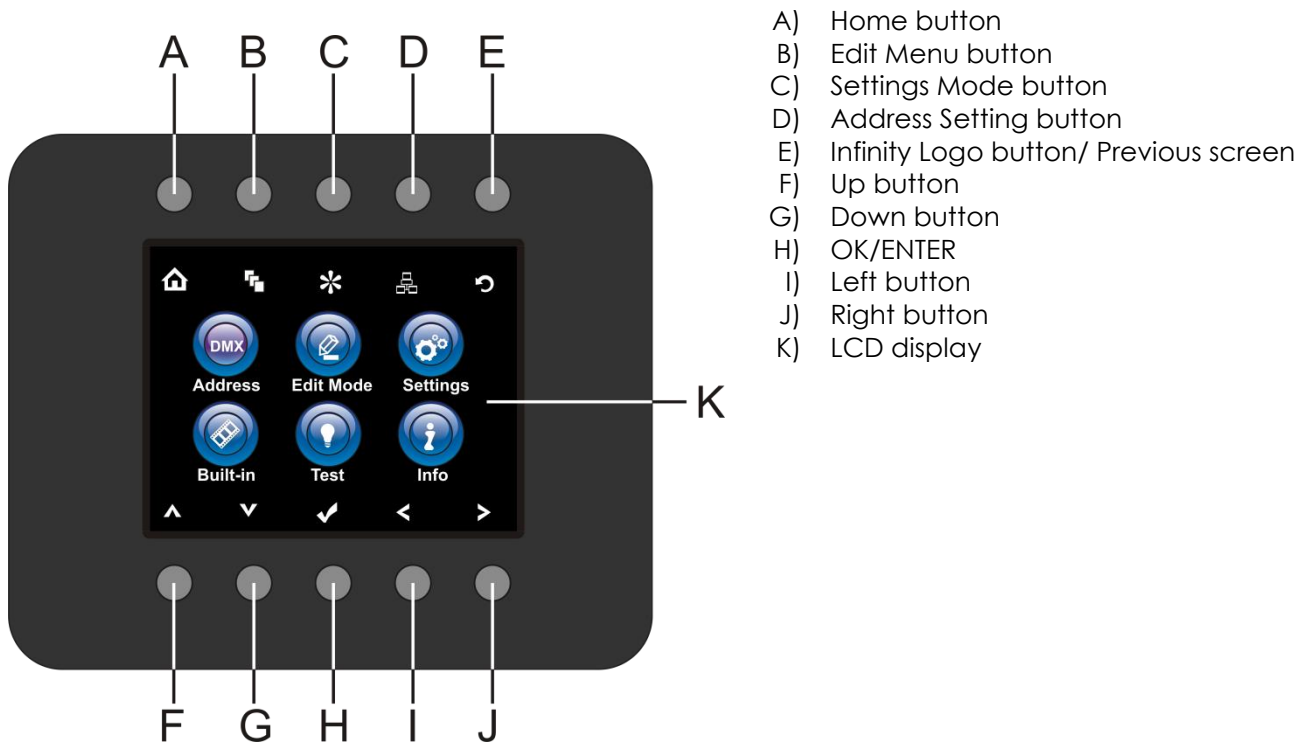

- A) Home button
- B) Edit Menu button
- C) Settings Mode button
- D) Address Setting button
- E) Infinity Logo button/ Previous screen
- F) Up button
- G) Down button
- H) OK/ENTER
- I) Left button
- J) Right button
- K) LCD display

Fig. 06

### Control Mode

The fixtures are individually addressed on a data-link and connected to the controller. The fixtures respond to the DMX signal from the controller. (When you select the DMX address and save it, the controller will display the saved DMX address the next time.)

### DMX Addressing

The control panel on the front side of the base allows you to assign the DMX fixture address, which is the first channel from which the Infinity will respond to the controller. Please note when you use the controller, the unit has **20** channels. When using multiple Infinities, make sure you set the DMX addresses right. Therefore, the DMX address of the first Infinity should be **1(001)**; the DMX address of the second Infinity should be **1+20=21 (021)**; the DMX address of the third Infinity should be **21+20=41 (041)**, etc. Please, be sure that you do not have any overlapping channels in order to control each Infinity correctly. If two or more Infinity's are addressed similarly, they will work similarly. For address settings, please refer to the instructions under "Addressing".

### Controlling:

After having addressed all Infinity fixtures, you may now start operating these via your lighting controller. **Note:** After switching on, the Infinity will automatically detect whether DMX 512 data is received or not. If not the problem may be:

- The XLR cable from the controller is not connected with the input of the Infinity.
- The controller is switched off or defective, the cable or connector is defective, or the signal wires are swapped in the input connector.

**Note:** It's necessary to insert a XLR termination plug (with 120 Ohm) in the last fixture in order to ensure proper transmission on the DMX data link.

### Display Off after 35 seconds

When no button is pressed for 35 seconds, the display will turn off. To light up the display, you have to press any of the buttons on the control panel. Once you have pressed the button, the display will light up.

Menu Overview



## Main Menu Options



DMX address



Edit Mode

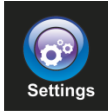

Settings Menu



Built-in Programs

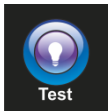

Test Mode



Info



Home



Up



Edit Menu



Down



Settings Mode



OK/Enter



Address Setting



Left



Previous screen/Infinity Logo



Right

### 1. DMX Address

With this menu you can set the DMX address.

01) Press the  button.

02) Press the  button, to confirm. You can choose 512 different DMX addresses.

03) Press the     buttons to select the required address from **001** <sup>Up/Down</sup> **512**.

04) Once you have set the desired DMX address, press the  button to store your DMX address.





## 2. Edit Mode

With this menu you can set your desired DMX personality and running mode.

01) Press the  button and select  .

02) Press the  button, to confirm. You can choose between 3 submenus.



03) Press the   buttons to select the desired DMX channels.

04) Press the  button, to confirm.

05) Once you have selected the desired DMX channels, press the   buttons to change the value from NO to YES.

06) Once you have selected the desired setting, press the  button to store your settings.





07) If you have chosen Master Mode, press the   buttons to change the value from NO to YES.

08) If you choose NO in MASTER MODE the device will react as slave, it will react the same as its master device.



09) If you choose YES in MASTER MODE the device will react as the master, all other devices will react as a slave device.

### 3. Settings Menu

With this menu you can set your desired settings.

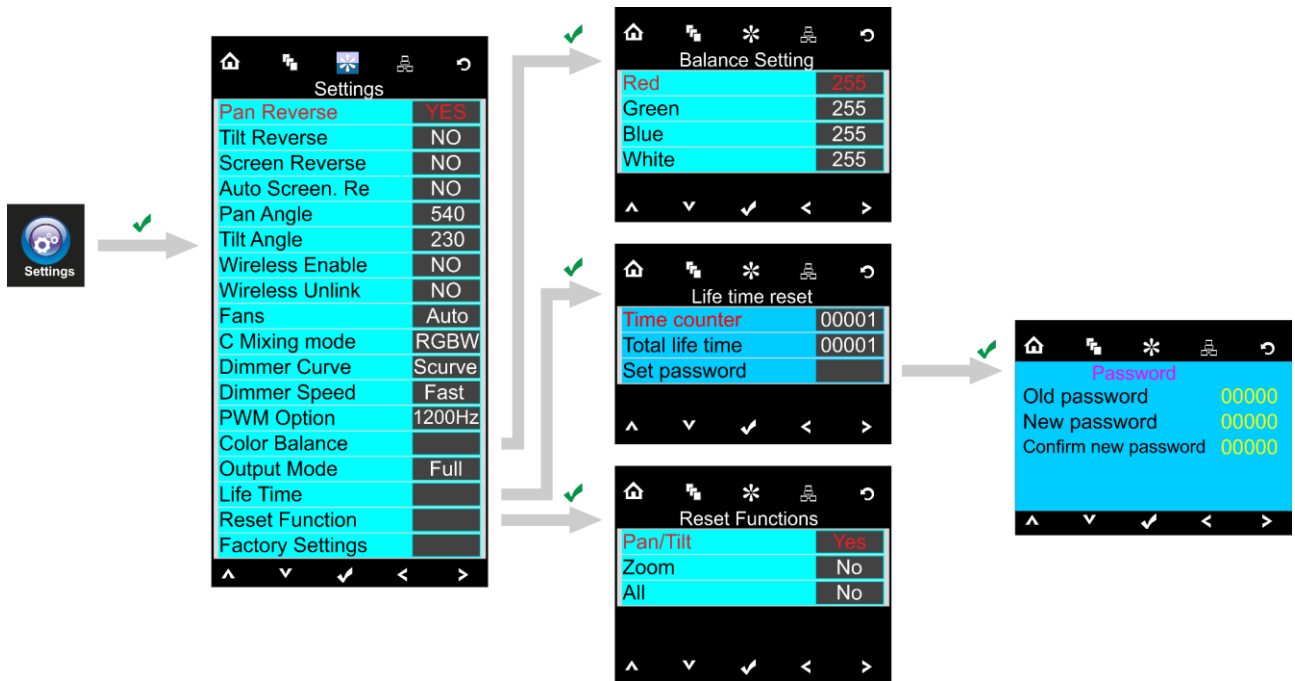





- 01) Press the  button and select .
- 02) Press the  button, to confirm. You can choose from 18 different options.
- 03) Press the   buttons to select the required mode:



- 04) Once you have selected the desired mode, press the  button to proceed to edition.
- 05) Press the   buttons to change the value from NO to YES.
- 06) Some of the available menus have different options to the regular, YES or NO function:
  - Pan Angle: 540°, 360°, 180°
  - Tilt Angle: 230°, 180°, 90°
  - Fans: Auto, Silent, Full
  - C Mixing Mode: RGBW, CMY
  - Dimmer Curve: Linear, Square, I Squa, SCurve
  - Dimmer Speed: Smooth, Fast
  - PWM Option: 600Hz, 1200Hz, 2000Hz, 4000Hz, 6000Hz, 15000Hz
  - Output Mode: White, Full









#### 3.1. Color Balance

With this menu you can set the device's color brightness.

- 01) Press the   buttons to select Color Balance and press the  button to open the menu.
- 02) You can now adjust 4 colors: Red, Green, Blue, White.
- 03) Choose the desired color, press the  button and then press the   buttons to set the value. The adjustment range is between 0-255, from dark to brightest.
- 04) You can combine Red, Green, Blue and White to create an infinite range of colors.

### 3.2. Life Time

With this menu you can reset the device's counters.





- 01) Press the   buttons to select Life Time and press the  button to open the menu.
- 02) Press the   buttons to choose one of the 3 reset options:
  - Time Counter (the time counter will be reset)
  - Total Life Time (the device's operation time counter will be reset)
  - Set Password
- 03) If you select Time Counter or Total Life Time, press the  button to open the selection menu.
- 04) Press the   buttons to choose either YES or NO. Press the  button to confirm.

#### 3.2.1. Set Password

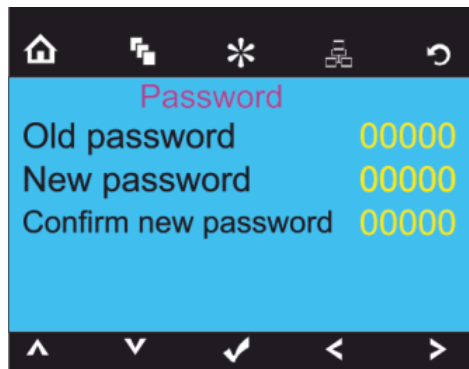
With this menu you can set the new password for the device.









- 01) Press the   buttons to select Set Password and press the  button to open the menu.
- 02) The following screen will pop up:



- 03) Press the   buttons to select the digit which you want to edit.
- 04) Press the   buttons to adjust the values.

### 3.3. Reset Functions

With this menu you can reset the device.

- 01) Press the   buttons to select Reset Functions and press the  button to open the menu.
- 02) Press the   buttons to choose one of the 3 reset options:
  - Pan/Tilt
  - Zoom
  - All
- 03) Press the   buttons to choose either YES or NO. Press the  button to confirm.
- 04) Once you have selected the desired setting, press the  button to store your settings.

## 4. Built-in Programs



With this menu you can choose your desired built-in program.

01) Press the  button and select .

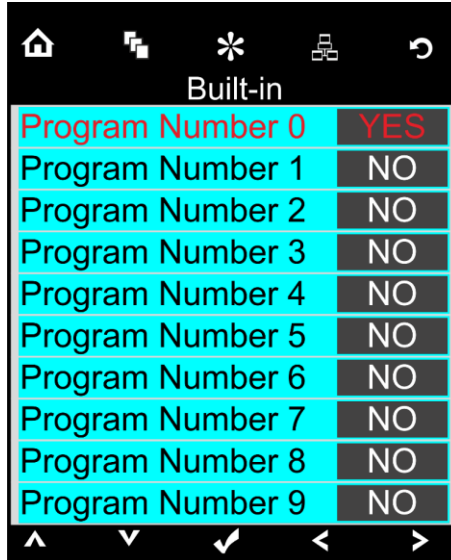
02) Press the  button, to confirm. You can choose 10 different built-in programs.



03) Press the Up / Down buttons to select the required program:

04) Once you have selected the desired built-in program, press the   buttons to change the value from NO to YES.

05) Once you have selected the desired setting, press the  button to store your settings.

06) If you have chosen YES the desired built-in program will start automatically.



**5. Test Menu**

With this menu you can test the device automatic or manual.

01) Press the  button and select .

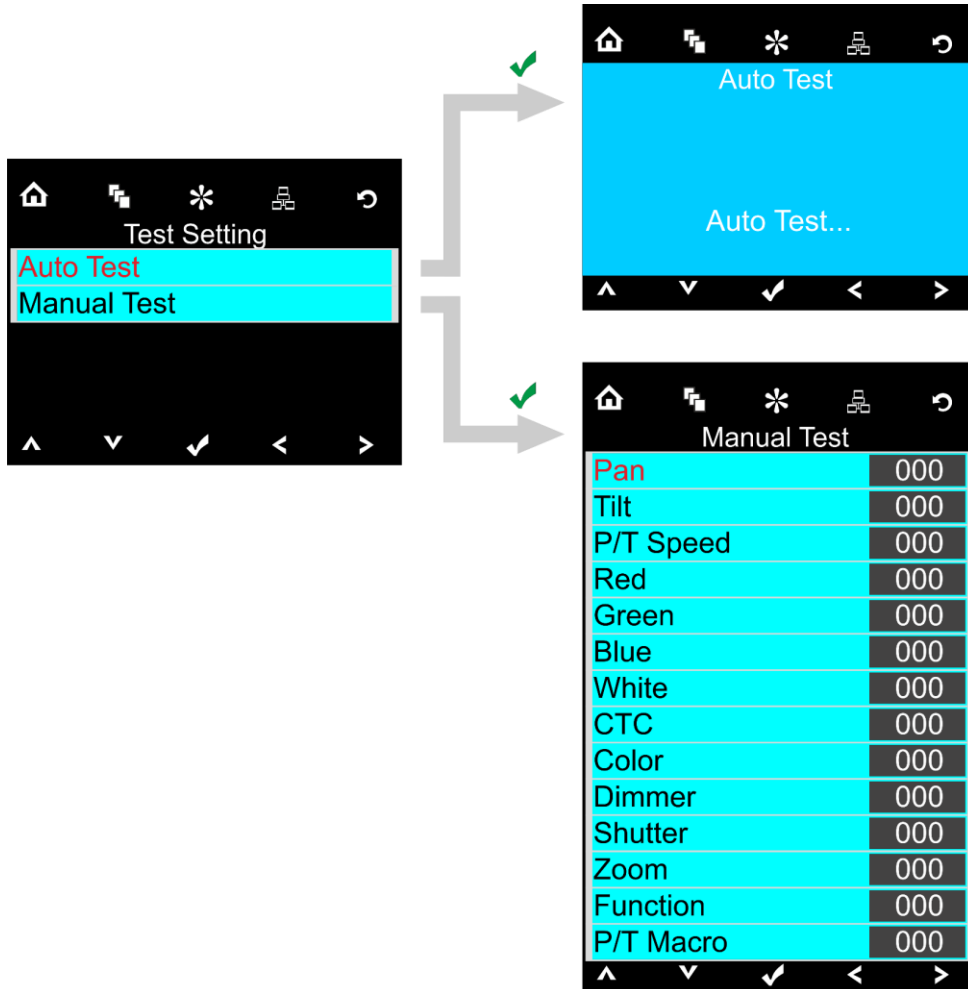
02) Press the  button, to confirm. You can choose 2 different test modes.





03) Press the   buttons to select the required test mode.



04) Press the  button, to confirm.

05) If you have chosen AUTO TEST the device will automatically start its auto test program.

06) If you have chosen MANUAL TEST you will enter a submenu. You can choose between 14 test options: Pan, Tilt, P/T Speed, Red, Green, Blue, White, CTC, Color, Dimmer, Shutter, Zoom, Function or P/T Macro.

07) Press the   buttons to select the required test option.

08) Press the  button, to confirm.

09) Once you have selected the desired option, press the   buttons to change the value from 000 to 255.

10) Once you have set the desired option, press the  button to store your settings.

## 6. Information Menu

With this menu you can see several device settings.

01) Press the  button and select .

02) Press the  button, to confirm.

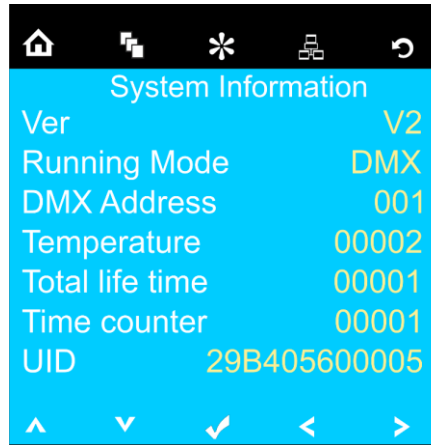

03) You can view 7 parameters.

## DMX Channels

### 20 Channels

#### Channel 1 – Horizontal movement (Pan)

Move the slider up, in order to move head horizontally (PAN).  
Gradual head adjustment from one end of the slider to the other (0-255, 128-center).  
The head can be turned by 540° and stopped at any position you wish.

#### Channel 2 – Vertical movement (Tilt)

Move the slider up, in order to move head vertically (TILT).  
Gradual head adjustment from one end of the slider to the other (0-255, 128-center).  
The head can be turned by 230° and stopped at any position you wish.

#### Channel 3 – Pan fine 16 bit

#### Channel 4 – Tilt fine 16 bit

#### Channel 5 – Pan / Tilt speed

0-255 From Max Speed (0) to Min. Speed (255)

#### Channel 6 – Red Dimmer intensity (CH16 must be set between 1-255 and CH18 between 20-255 )

0-255 Gradual adjustment Red from 0-100%

#### Channel 7 – Red Dimmer intensity 16Bit

#### (CH6, CH16 and CH17 must be set between 1-255 and CH18 between 20-255 )

0-255 Fine gradual adjustment Red from 0-100%

#### Channel 8 – Green Dimmer intensity (CH16 must be set between 1-255 and CH18 between 20-255 )

0-255 Gradual adjustment Green from 0-100%

#### Channel 9 – Green Dimmer intensity 16Bit

#### (CH8, CH16 and CH17 must be set between 1-255 and CH18 between 20-255 )

0-255 Fine gradual adjustment Green from 0-100%

#### Channel 10 – Blue Dimmer intensity (CH16 must be set between 1-255 and CH18 between 20-255 )

0-255 Gradual adjustment Blue from 0-100%

#### Channel 11 – Blue Dimmer intensity 16Bit

#### (CH10, CH16 and CH17 must be set between 17-255 and CH18 between 20-255 )

0-255 Fine gradual adjustment Blue from 0-100%

#### Channel 12 – White Dimmer intensity (CH16 must be set between 1-255 and CH18 between 20-255 )

0-255 Gradual adjustment White from 0-100%

#### Channel 13 – White Dimmer intensity 16Bit

#### (CH12, CH16 and CH17 must be set between 7-255 and CH18 between 20-255 )

0-255 Fine gradual adjustment White from 0-100%

#### Channel 14 – CTC correction (CH6 CH8, CH10, CH12, CH15, CH16 must be set between 1-255 and CH18 must be set between 20-255 )

0 No function

1-255 Color temperature correction from 19000K to 2700K

**Channel 15 – Color correction (CH16 must be set between 1-255 and CH18 must be set between 20-255**



0	No function
1-2	White 2700K(R=156, G=118, B=0, W=63)
3-4	White 3200K(R=156, G=141, B=5, W=89)
5-6	White 4200K(R=156, G=141, B=14, W=255)
7-8	White 5600K(R=156, G=207, B=54, W=255)
9-10	White 8000K(R=130, G=255, B=96, W=255)
11	Blue (R=0, G=0, B=255, W=0)
12-48	R=0, G+, B=255, W=0
49	Cyan (R=0, G=255, B=255, W=0)
50-86	R=0, G=255, B-, W=0
87	Green (R=0, G=255, B=0, W=0)
88-124	R+, G=255, B=0, W=0
125	Yellow (R=255, G=255, B=0, W=0)
126-162	R=255, G-, B=0, W=0
163	Red (R=255, G=0, B=0, W=0)
164-200	R=255, G=0, B+, W=0
201	Magenta (R=255, G=0, B=255, W=0)
202-238	R-, G=0, B=255, W=0
239	Blue (R=0, G=0, B=255, W=0)
240-247	Color fade with decreasing speed
248-255	Color jump with decreasing speed

**Channel 16 – Dimmer (CH6, CH8, CH10, CH12, CH14, CH15 must be set between 1-255 or CH18 must be set between 20-255**



0-255	Dimmer intensity, from dark to brightest
-------	--

**Channel 17 – Dimmer 16Bit (CH6, CH8, CH10, CH12, CH14, CH15 must be set between 1-255 or CH18 must be set between 20-255**



0-255	Fine dimmer intensity, from dark to brightest
-------	---

**Channel 18 – Shutter / Strobe (CH6, CH8, CH10, CH12, CH14, CH15 must be set between 1-255 or CH18 must be set between 20-255**



0-19	Shutter closed
20-24	Shutter open
25-64	Strobe 1 with decreasing speed
65-69	Shutter open
70-84	Strobe 2(fast on slow off) with decreasing speed
85-89	Shutter open
90-104	Strobe 3(slow on fast off) with decreasing speed
105-109	Shutter open
110-124	Strobe 4(random strobe) with decreasing speed
125-129	Shutter open
130-144	Strobe 5(random fast on slow off)with decreasing speed
145-149	Shutter open
150-164	Strobe 6(random slow on fast off) with decreasing speed
165-169	Shutter open
170-184	Strobe 7(pulse strobe) with decreasing speed
185-189	Shutter open
190-204	Strobe 8(random pulse strobe) with decreasing speed
205-209	Shutter open
210-224	Strobe 9(fade on or off) with decreasing speed
225-229	Shutter open
230-244	Strobe 10(pulse strobe) with decreasing speed
245-255	Shutter open



## Channel 19– Zoom

0-255 Gradual zoom adjustment, from small to big (3,6°-60°)

## Channel 20 – Channel Functions (Desired function starts after 5 seconds setting DMX value)

0-9	No Function
10-14	Pan/Tilt black activated, after 3 seconds
15-19	reserved
20-24	RGBW color mixing, after 3 seconds
25-29	CMY color mixing, after 3 seconds
30-34	LED built-in Delay Off, after 3 seconds
35-39	LED built-in Delay On, after 3 seconds
40-44	Reserved
45-49	Reserved
50-54	Pan reset, after 3 seconds
55-59	Tilt reset, after 3 seconds
60-64	Zoom reset, after 3 seconds
65-69	Reserved
70-74	All reset, after 3 seconds
75-79	Reserved
80-84	Reserved
85-89	Reserved
90-94	Reserved
95-99	Reserved
100-104	Reserved
105-109	Reserved
110-114	Reserved
115-119	Reserved
120-124	Fan low speed
125-129	Fan full speed
130-134	Fan auto
135-139	Dimmer fast
140-144	Dimmer smooth
145-164	No function
165-169	Output = Full
170-174	Output = White
175-247	Reserved
248-255	Reserved

**15 Channels**

**Channel 1 – Horizontal movement (Pan)**

Move the slider up, in order to move head horizontally (PAN).  
 Gradual head adjustment from one end of the slider to the other (0-255, 128-center).  
 The head can be turned by 540° and stopped at any position you wish.

**Channel 2 – Vertical movement (Tilt)**

Move the slider up, in order to move head vertically (TILT).  
 Gradual head adjustment from one end of the slider to the other (0-255, 128-center).  
 The head can be turned by 230° and stopped at any position you wish.

**Channel 3 – Pan fine 16 bit**

**Channel 4 – Tilt fine 16 bit**

**Channel 5 – Pan / Tilt speed**

0-255 From Max Speed (0) to Min. Speed (255)

**Channel 6 – Red Dimmer intensity (CH12 must be set between 1-255 and CH13 between 20-255  )**

0-255 Gradual adjustment Red from 0-100%

**Channel 7 – Green Dimmer intensity (CH12 must be set between 1-255 and CH13 between 20-255  )**

0-255 Gradual adjustment Green from 0-100%

**Channel 8 – Blue Dimmer intensity (CH12 must be set between 1-255 and CH13 between 20-255  )**

0-255 Gradual adjustment Blue from 0-100%

**Channel 9 – White Dimmer intensity (CH12 must be set between 1-255 and CH13 between 20-255  )**

0-255 Gradual adjustment White from 0-100%

**Channel 10 – CTC correction (CH6, CH7, CH8, CH9, CH10, CH12 must be set between 1-255 and CH13 must be set between 20-255  )**

0 No function  
 1-255 Color temperature correction from 19000K to 2700K

**Channel 11 – Color correction (CH12 must be set between 1-255 and CH13 must be set between 20-255  )**

0 No function  
 1-2 White 2700K(R=156, G=118, B=0, W=63)  
 3-4 White 3200K(R=156, G=141, B=5, W=89)  
 5-6 White 4200K(R=156, G=141, B=14, W=255)  
 7-8 White 5600K(R=156, G=207, B=54, W=255)  
 9-10 White 8000K(R=130, G=255, B=96, W=255)  
 11 Blue (R=0, G=0, B=255, W=0)  
 12-48 R=0, G+, B=255, W=0  
 49 Cyan (R=0, G=255, B=255, W=0)  
 50-86 R=0, G=255, B-, W=0  
 87 Green (R=0, G=255, B=0, W=0)  
 88-124 R+, G=255, B=0, W=0  
 125 Yellow (R=255, G=255, B=0, W=0)  
 126-162 R=255, G-, B=0, W=0  
 163 Red (R=255, G=0, B=0, W=0)  
 164-200 R=255, G=0, B+, W=0  
 201 Magenta (R=255, G=0, B=255, W=0)  
 202-238 R-, G=0, B=255, W=0

239	Blue (R=0, G=0, B=255, W=0)
240-247	Color fade with decreasing speed
248-255	Color jump with decreasing speed

**Channel 12 – Dimmer (CH5, CH6, CH7, CH8, CH9, CH10 must be set between 1-255 and CH13 must be set between 20-255  )**

0-255	Dimmer intensity, from dark to brightest
-------	--

**Channel 13 – Shutter / Strobe (CH6, CH7, CH8, CH9, CH10, CH11 must be set between 1-255  )**

0-19	Shutter closed
20-24	Shutter open
25-64	Strobe 1 with decreasing speed
65-69	Shutter open
70-84	Strobe 2(fast on slow off) with decreasing speed
85-89	Shutter open
90-104	Strobe 3(slw on fast off) with decreasing speed
105-109	Shutter open
110-124	Strobe 4(random strobe) with decreasing speed
125-129	Shutter open
130-144	Strobe 5(random fast on slow off)with decreasing speed
145-149	Shutter open
150-164	Strobe 6(random slow on fast off) with decreasing speed
165-169	Shutter open
170-184	Strobe 7(pulse strobe) with decreasing speed
185-189	Shutter open
190-204	Strobe 8(random pulse strobe) with decreasing speed
205-209	Shutter open
210-224	Strobe 9(fade on or off) with decreasing speed
225-229	Shutter open
230-244	Strobe 10(pulse strobe) with decreasing speed
245-255	Shutter open

**Channel 14– Zoom**

0-255	Gradual zoom adjustment, from small to big (3,6°-60°)
-------	---

**Channel 15 – Channel Functions (Desired function starts after 5 seconds setting DMX value)**

0-9	No Function
10-14	Pan/Tilt black activated, after 3 seconds
15-19	reserved
20-24	RGBW color mixing, after 3 seconds
25-29	CMY color mixing, after 3 seconds
30-34	LED built-in Delay Off, after 3 seconds
35-39	LED built-in Delay On, after 3 seconds
40-44	Reserved
45-49	Reserved
50-54	Pan reset, after 3 seconds
55-59	Tilt reset, after 3 seconds
60-64	Zoom reset, after 3 seconds
65-69	Reserved
70-74	All reset, after 3 seconds
75-79	Reserved
80-84	Reserved
85-89	Reserved
90-94	Reserved
95-99	Reserved
100-104	Reserved

105-109	Reserved
110-114	Reserved
115-119	Reserved
120-124	Fan low speed
125-129	Fan full speed
130-134	Fan auto
135-139	Dimmer fast
140-144	Dimmer smooth
145-164	No function
165-169	Output = Full
170-174	Output = White
175-247	Reserved
248-255	Reserved

## Maintenance

The operator has to make sure that safety-related and machine-technical installations are to be inspected by an expert after every year in the course of an acceptance test.

The operator has to make sure that safety-related and machine-technical installations are to be inspected by a skilled person once a year.

The following points have to be considered during the inspection:

- 01) All screws used for installing the device or parts of the device have to be tightly connected and must not be corroded.
- 02) There may not be any deformations on housings, fixations and installation spots.
- 03) Mechanically moving parts like axles, eyes and others may not show any traces of wearing.
- 04) The electric power supply cables must not show any damages or material fatigue.

The Showtec Infinity iW-741 RDM requires almost no maintenance. However, you should keep the unit clean. Otherwise, the fixture's light-output will be significantly reduced. Disconnect the mains power supply and then wipe the cover with a damp cloth. Wipe the front glass panel clean with glass cleaner and a soft cloth. Do not use alcohol or solvents. The front glass panel will require weekly cleaning, as smoke-fluid tends to build up residues, reducing the light output very quickly. Do not immerse in liquid. The cooling-fans and the internal lenses should be cleaned monthly with a soft brush.

Please clean internal components once a year with a light brush and vacuum cleaner.

Keep connections clean. Disconnect electric power, and then wipe the DMX and audio connections with a damp cloth. Make sure connections are thoroughly dry before linking equipment or supplying electric power.

## Replacing a Fuse

Power surges, short-circuit or inappropriate electrical power supply may cause a fuse to burn out. If the fuse burns out, the product will not function whatsoever. If this happens, follow the directions below.

- 01) Unplug the unit from electric power source.
- 02) Insert a screwdriver into the slot in the fuse cover. Turn the screwdriver to the left, at the same time gently push a bit (Turn and Push). The fuse will come out.
- 03) Remove the used fuse. If brown or unclear, it is burned out.
- 04) Insert the replacement fuse into the holder where the old fuse was. Reinsert the fuse cover. Be sure to use a fuse of the same type and specification. See the product specification label for details.

## Troubleshooting

---

### No Light

This troubleshooting guide is meant to help solve simple problems.

If a problem occurs, carry out the steps below in sequence until a solution is found. Once the unit operates properly, do not carry out following steps.

If the light effect does not operate properly, refer servicing to a technician.

Suspect four potential problem areas as: factory reset, the power supply, the LEDs, the fuse.

First try to reset the device to its original factory default settings (**3. Settings Menu** see page 17).

- 01) Power supply. Check that the unit is plugged into an appropriate power supply.
- 02) The LEDs. Return the Infinity to your Showtec dealer.
- 03) The fuse. Replace the fuse. See page 27 for replacing the fuse.
- 04) If all of the above appears to be O.K., plug the unit in again.
- 05) If you are unable to determine the cause of the problem, do not open the Infinity, as this may damage the unit and the warranty will become void.
- 06) Return the device to your Showtec dealer.

### No Response to DMX

Suspect the DMX cable or connectors, a controller malfunction, a light effect DMX card malfunction.

- 01) Check the DMX setting. Make sure that DMX addresses are correct.
- 02) Check the DMX cable: Unplug the unit; change the DMX cable; then reconnect to electrical power. Try your DMX control again.
- 03) Determine whether the controller or light effect is at fault. Does the controller operate properly with other DMX products ? If not, take the controller in for repair. If so, take the DMX cable and the light effect to a qualified technician.

Problem	Probable cause(s)	Remedy
One or more fixtures do not function at all.	No power to the fixture.	<ul style="list-style-type: none"> <li>• Check if power is switched on and cables are plugged in.</li> </ul>
	Primary fuse blown.	<ul style="list-style-type: none"> <li>• Replace fuse.</li> </ul>
Fixtures reset correctly, but all respond erratically or not at all to the controller.	The controller is not connected.	<ul style="list-style-type: none"> <li>• Connect controller.</li> </ul>
	3-pin/5-pin XLR Out of the controller does not match XLR Out of the first fixture on the link (i.e. signal is reversed).	<ul style="list-style-type: none"> <li>• Install a phase reversing cable between the controller and the first fixture on the link.</li> </ul>
Fixtures reset correctly, but some respond erratically or not at all to the controller.	Poor data quality	<ul style="list-style-type: none"> <li>• Check data quality. If much lower than 100 percent, the problem may be a bad data link connection, poor quality or broken cables, missing termination plug, or a defective fixture disturbing the link.</li> </ul>
	Bad data link connection	<ul style="list-style-type: none"> <li>• Inspect connections and cables. Correct poor connections. Repair or replace damaged cables.</li> </ul>
	Data link not terminated with 120 Ohm termination plug.	<ul style="list-style-type: none"> <li>• Insert termination plug in output jack of the last fixture on the link.</li> </ul>
	Incorrect addressing of the fixtures.	<ul style="list-style-type: none"> <li>• Check address setting.</li> </ul>
	One of the fixtures is defective and disturbs data transmission on the link.	<ul style="list-style-type: none"> <li>• Bypass one fixture at a time until normal operation is regained: unplug both connectors and connect them directly together.</li> <li>• Have the defective fixture serviced by a qualified technician.</li> </ul>
3-pin XLR Out on the fixtures does not match (pins 2 and 3 reversed).	<ul style="list-style-type: none"> <li>• Install a phase-reversing cable between the fixtures or swap pin 2 and 3 in the fixture that behaves erratically.</li> </ul>	
No light or LEDs cut out intermittently	Fixture is too hot.	<ul style="list-style-type: none"> <li>• Allow fixture to cool.</li> <li>• Clean fan.</li> <li>• Make sure air vents are not blocked.</li> <li>• Turn up the air conditioning .</li> </ul>
	LEDs damaged	<ul style="list-style-type: none"> <li>• Disconnect fixture and return to your dealer.</li> </ul>
	The power supply settings do not match local AC voltage and frequency.	<ul style="list-style-type: none"> <li>• Disconnect fixture. Check settings and correct if necessary.</li> </ul>

## Product Specifications

Model:	Infinity iW-741 RDM
Input Voltage:	100-240V AC, 50/60Hz (auto ranging)
Power consumption:	310W (full output)
DMX linking:	30pcs
Power linking @120V	3pcs
Power linking @240V	7pcs
Fuse:	F5A/250V
Dimensions:	290 x 204 x 418 mm (LxWxH)
Weight:	9,36 kg
<b>Operating and Programming:</b>	
Signal pin OUT:	Pin 1 (earth), pin 2 (-), pin 3 (+)
DMX Mode:	15, 20 channels
Signal input:	3-pin XLR IN
Signal output:	3-pin XLR OUT
<b>Electro-mechanical effects:</b>	
Light source:	7 x 40W RGBW 4-in-1 Osram
Lux @ 3 m:	41888
Color mixing:	RGBW, CMY
Beam angle:	3,6°-60°
Motorized zoom:	3,6°-60°
Dimmer:	0-100%, 16 bit
Dimmer speed:	Smooth, Fast
Strobe:	0-20Hz
Pan:	540°
Tilt:	230°
Pan/Tilt resolution:	16 bit
Dimming Curves:	Linear, Square, Inv-Square, S-curve
Housing:	Metal & Flame retardant plastic
IP rating:	IP20
DMX control:	via standard DMX/RDM controller
Onboard:	Battery powered full color display including gravity sensor
Wireless DMX:	Optional available
Color balance:	Separate RGBW adjustment
Control:	DMX-512, Master/Slave, Built-in Programs
Connections:	3-pin XLR data IN/OUT, Neutrik PowerCON IN/OUT
Max. ambient temperature $t_a$ :	45°C
Max. housing temperature $t_B$ :	80°C
<b>Minimum distance:</b>	
Minimum distance from flammable surfaces:	0,5 m
Minimum distance to lighted object:	1,5 m

Design and product specifications are subject to change without prior notice.



Website: [www.Showtec.info](http://www.Showtec.info)  
 Email: [service@highlite.com](mailto:service@highlite.com)

## Dimensions

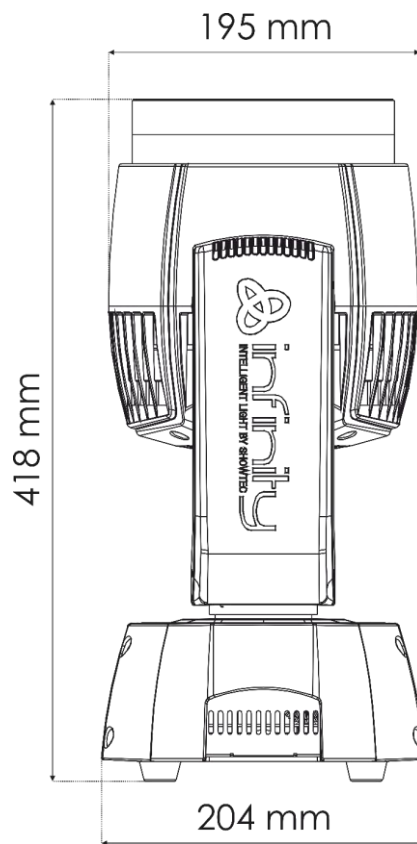
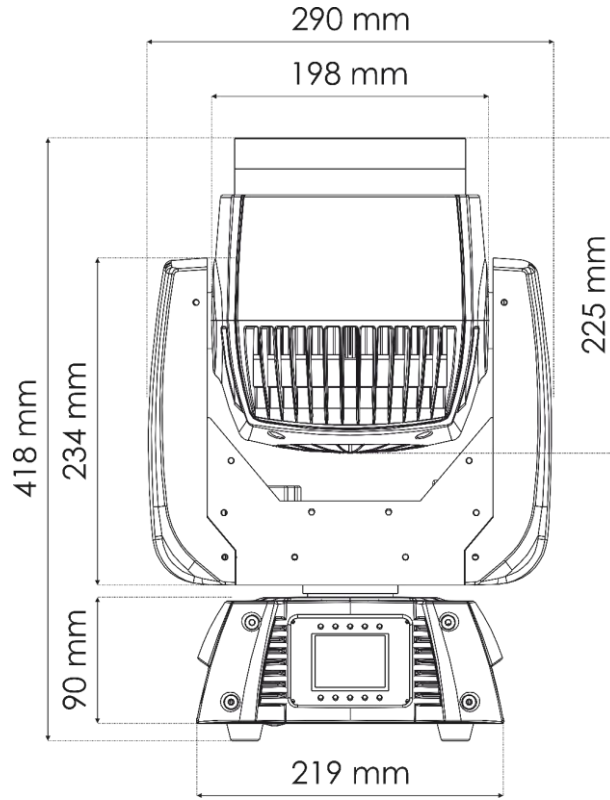











©2019 Infinity